



World's Finest Products For Harley-Davidsons

NEW PRODUCTS - 2024



World's Finest Products For Harley-Davidsons





Deep Cut Saddlebag Latch Covers

- CNC machined from billet aluminum
- Accepts factory saddlebag lock and hardware
- Sold in pairs

Part#: 930129 , **Fitment:** 14-24 Touring, (except 14-18 FLHRC, 23-24 FLHXSE, 23-24 FLTRXSE, 24 FLTRXSTSE, 24 FLHX, 24 FLTRX) , **Color:** Black Cut, Anodized , **Unit:** Pair , **Qty.:** 1



895286



895287



930130



10-Gauge Saddlebag Latch Covers

- CNC machined from billet aluminum
- Accepts factory saddlebag lock and hardware
- Sold in pairs

Fitment: 14-24 Touring, (except 14-18 FLHRC, 23-24 FLHXSE, 23-24 FLTRXSE, 24 FLTRXSTSE, 24 FLHX, 24 FLTRX) , **Unit:** Pair , **Qty.:** 1

PART#	COLOR
919428	Black, Anodized
919429	Black Cut, Anodized
919430	Chrome
930130	Gold



New Style Latch Covers

Give your saddlebags a new style !
 Made from aluminum with a high-end finish
 Fits with OE mounting material and saddlebag lock

Fitment: 23-24 FLHXSE, 23-24 FLTRXSE, 24 FLHX, 24 FLTRX, 24 FLTRXSTSE , **Unit:** Pair , **Qty.:** 1

PART#	COLOR
930286	Black Satin
930287	Chrome



MX Driver Floorboards

- CNC machined from billet aluminum
- Features machined detail on top and side of floorboard
- Rubber inserts offer foot traction and protects finish of floorboard
- Extended length for added comfort

Unit: Pair , Qty.: 1

FITMENT	BLACK ANODIZED	CHROME	GOLD ANODIZED
18-21 FLSL, 18-20 FLDE, 18-20 FLFB, 18-20 FLFBS 114, 18 FLFBS 114 ANX, 18 FLFBS 114 ANV, 18-21 FLHC, 18 FLHCS 114, 18 FLHCS 114 ANV, 19-20 FLHC 114, 21-24 FLFBS, 21-24 FLHCS, 23 FLHCSANV, 23 FLFBS ANV	930232	930233	930234
85-24 Touring, 09-24 Trike, 86-90 FLST, 88-03, 07-12, 14-17 FLSTC, 90-00, 03-12, 14-17 FLSTF, 93-96, 07-12, 14-17 FLSTN, 97-03 FLSTS, 01-06 FLSTCI, 01-06 FLSTFI, 01-03 FLSTSI, 05 FLSTFSE, 06 FLSTFSE2, 06 FLSTI, 06 FLSTNI, 06 FLSTSCI, 07 FLSTSC, 08-11 FLSTSB, 10-12, 14-17 FLSTFB, 10 FLSTSE, 11 FLSTSE2, 12, 14-17 FLS, 12 FLSTSE3, 13 FLS 103, 13 FLSTC 103, 13 FLSTC 103 ANV, 13 FLSTF 103, 13 FLSTFB 103, 13 FLSTN103, 14-15 FLSTNSE, 16-17 FLSS, 16-17 FLSTFBS, 12, 14-16 FLD, 13 FLD103, 80-84 FLT, 81-84 FLTC	921668	930227	930499



BLACK CUT ANODIZED

CHROME



10-Gauge Driver Floorboards

- Lightweight cut-through design
- Longer than stock for extra foot room and added comfort
- Rubber inserts are located on the top of the board for foot traction
- 18" L X 5.75" W X 1" thick

Unit: Pair , Qty.: 1

FITMENT	BLACK CUT ANODIZED PART#	CHROME PART#
18-21 FLSL, 18-20 FLDE, 18-20 FLFB, 18-20 FLFBS 114, 18 FLFBS 114 ANX, 18 FLFBS 114 ANV, 18-21 FLHC, 18 FLHCS 114, 18 FLHCS 114 ANV, 19-20 FLHC 114, 21-24 FLFBS, 21-24 FLHCS, 23 FLHCSANV, 23 FLFBS ANV	930230	930231
85-24 Touring, 09-24 Trike, 86-90 FLST, 88-03, 07-12, 14-17 FLSTC, 90-00, 03-12, 14-17 FLSTF, 93-96, 07-12, 14-17 FLSTN, 97-03 FLSTS, 01-06 FLSTCI, 01-06 FLSTFI, 01-03 FLSTSI, 05 FLSTFSE, 06 FLSTFSE2, 06 FLSTI, 06 FLSTNI, 06 FLSTSCI, 07 FLSTSC, 08-11 FLSTSB, 10-12, 14-17 FLSTFB, 10 FLSTSE, 11 FLSTSE2, 12, 14-17 FLS, 12 FLSTSE3, 13 FLS 103, 13 FLSTC 103, 13 FLSTC 103 ANV, 13 FLSTF 103, 13 FLSTFB 103, 13 FLSTN103, 14-15 FLSTNSE, 16-17 FLSS, 16-17 FLSTFBS, 12, 14-16 FLD, 13 FLD103, 80-84 FLT, 81-84 FLTC	895335	895334



684520



684521



Deep Cut Floorboards

- Timeless design
- Stretched profile
- Eye catching style at every angle
- CNC machined from forged billet aluminum
- Features machined cuts on top and side of floorboard
- Rubber inserts offer foot traction and protects finish of floorboard
- Extended length for added comfort
- Dimensions: 18" Long x 5.75" Wide x 1" Thick

Unit: Pair , Qty.: 1

FITMENT

	BLACK CUT ANODIZED	CHROME
18-21 FLSL, 18-20 FLDE, 18-20 FLFB, 18-20 FLFBS 114, 18 FLFBS 114 ANX, 18 FLFBS 114 ANV, 18-21 FLHC, 18 FLHCS 114, 18 FLHCS 114 ANV, 19-20 FLHC 114, 21-24 FLFBS, 21-24 FLHCS, 23 FLHCSANV, 23 FLFBS ANV	930228	930229
85-24 Touring, 09-24 Trike, 86-90 FLST, 88-03, 07-12, 14-17 FLSTC, 90-00, 03-12, 14-17 FLSTF, 93-96, 07-12, 14-17 FLSTN, 97-03 FLSTS, 01-06 FLSTCI, 01-06 FLSTFI, 01-03 FLSTSI, 05 FLSTFSE, 06 FLSTFSE2, 06 FLSTI, 06 FLSTNI, 06 FLSTSCI, 07 FLSTSC, 08-11 FLSTSB, 10-12, 14-17 FLSTFB, 10 FLSTSE, 11 FLSTSE2, 12, 14-17 FLS, 12 FLSTSE3, 13 FLS 103, 13 FLSTC 103, 13 FLSTC 103 ANV, 13 FLSTF 103, 13 FLSTFB 103, 13 FLSTN103, 14-15 FLSTNSE, 16-17 FLSS, 16-17 FLSTFBS, 12, 14-16 FLD, 13 FLD103, 80-84 FLT, 81-84 FLTC	684521	684520



Deep Cut Passenger Floorboards

- Machined from two pieces of billet aluminum to create a cutting-edge see-through design
- Adds exceptional style and comfort to your bike
- Includes all mounting hardware
- Matching driver boards available (sold separately)
- Passenger floorboards: 7" L x 4" W x 1" thick

Fitment: 86-24 Touring, 09-24 Trike, 84-17 Softail , Fitment Note: Fits Softail models with OEM floorboard mounting kit, except models with upper exhaust , Unit: Pair , Qty.: 1

PART# | COLOR

684524 | Black, Anodized

930226 | Chrome



550047



550048



550049



Knurled Rubber Shift/Brake Peg

- Knurled rubber brake/shift peg
- Made of billet aluminum

Fitment: 86-20 Sportster, 85-94 FX Model, 91-17 Dyna, 84-24 Softail, 85-24 Touring, 09-24 Trike, 66-84 FL Shovel, 71-84 FX Shovel, 65 Panhead , **Fitment Note:** Fits all HD models with two piece shift lever , **Unit:** Each , **Qty.:** 1

PART#	COLOR
550049	Black Anodized
550047	Brass
550048	Chrome
930215	Gold Anodized



917851

917852

930225

Ness-MX Footpegs

- CNC machined from billet aluminum
- Does not include splined footpeg mounts
- Arlen Ness footpeg mounts available for Harley (incl. M8) and Indian applications
- Detailed machine style accents
- Allowing rider to adjust pegs to their preferred angle
- Stainless steel replaceable peg sliders
- Integrated rubber inserts

Fitment: 91-20 Sportster, 91-17 Dyna, 86-24 Softail, 02-17 V-Rod, 15-24 Indian Bagger, 14-24 Indian Cruiser, 15-24 Scout, 16-20, 23-24 Scout Sixty, 19-24 Scout Bobber, 21-24 Scout Bobber Twenty, 22 Scout Rogue , 23-24 Scout Bobber Sixty, 23-24 Scout Rogue Sixty, 23-24 Scout Rogue , **Field of Application:** For use with peg clevis 917853, 917854, 917855, 917856 and 917857 , **Fitment Note:** Require Splined Mounts (sold seperately) , **Description:** (No Mounts included) , **Unit:** Pair , **Qty.:** 1

PART#	COLOR
917851	Chrome
917852	Black, Anodized
930225	Gold, Anodized



917856, 917857

917854, 917855

917853

MX Peg Clevis

- CNC machined billet aluminum footpeg mounts
- Adjustable splined mounting system
- Pre-locktited hardware

Color: Black, **Material:** Aluminium, **Unit:** Pair, **Qty.:** 1.0

PART#	FITMENT	FITMENT NOTE
917857	15-22 Indian Bagger, 12-22 Indian Cruiser	
917856	15-20 Indian Midsize, except 19-21 FTR 1200, 19-20 FTR 1200 S, 21 FTR S, 21 FTR Rally, 21 FTR R Carbon, 22 FTR , 22 FTR S , 22 FTR Rally , 22 FTR R Carbon	
917854	18-22 Softail	Except Model, equipped with Rider Floorboards.
917855	18-22 Softail	
917853		all HD with Male Mount

NEW PRODUCTS



930201

930202

930205



Diamond Passenger Pegs

- Diamond footpegs feature a diamond rubber pattern with integrated knurling inside
- Each diamond shaped pocket resulting in foot traction
- CNC machined billet aluminum end caps with laser engraved Arlen Ness logo
- Forged clevis and internal structure for optimum strength
- Reduced shorty length for increased ground clearance

Fitment: 18-24 Softail , Fitment Note: For OEM mount , Unit: Pair , Qty.: 1

PART#	COLOR	DESCRIPTION
930201	Black	Black Rubber Peg, Black End Cap
930202	Chrome	Black Rubber Peg, Chrome End Cap
930205	Gold	Black Rubber Peg, Gold End Cap



930197

930198

930206



Diamond Shift Peg

- Diamond design shift peg
- Diamond rubber pegs provides excellent foot traction with an overall clean style
- Features a CNC machined billet end cap
- Laser engraved Arlen Ness logo
- Integrated mounting stud

Fitment: 86-20 Sportster, 85-94 FX Model, 91-17 Dyna, 84-24 Softail, 85-24 Touring, 09-24 Trike, 66-84 FL Shovel, 71-84 FX Shovel, 65 Panhead , Fitment Note: Fits all HD models with two piece shift lever , Unit: Each , Qty.: 1

PART#	COLOR	DESCRIPTION
930197	Black	Black Rubber Peg, Black End Cap
930198	Chrome	Black Rubber Peg, Chrome End Cap
930206	Gold	Black Rubber Peg, Gold End Cap



930195

930196

930203

930199

930200

930204



Diamond Footpegs

- Diamond footpegs feature a diamond rubber pattern with integrated knurling inside
- Each diamond shaped pocket resulting in foot traction
- CNC machined billet aluminum end caps with laser engraved Arlen Ness logo
- Forged clevis and internal structure for optimum strength
- Reduced shorty length for increased ground clearance

Unit: Pair , Qty.: 1

FITMENT	BLACK RUBBER PEG, BLACK END CAP	BLACK RUBBER PEG, CHROME END CAP	BLACK RUBBER PEG, GOLD END CAP
21-24 Pan America, 20-21 LiveWire, 21-24 Sportster RH, 18-19, 23-24 FXBR, 18-20 FXBRS 114, 18 FXBRS 114 ANX, 18-20 FXFB, 18, 20 FXFBS 114, 18-20 FXLR, 18-20 FXBB, 18-24 FL5B, 19-20 FXDRS 114, 19 FXFB 114, 20-24 FXLRS, 20-24 FXST, 21-24 FXBBS, 21-22 FXBRS, 21-24 FXFBS, 22-24 FXLRST, 22 FXRST	930199	930200	930204
91-20 Sportster, (except 10-20 XL1200X, 11-20 XL1200C, 11-20 XL883L, 12-13, 15-16 XL1200V, 13 XL1200C ANV, 13-16 XL1200CA, 13-17 XL1200CB, 18 XL1200X ANX, 19-20 XL1200XS), 85-94 FX Model, 91-17 Dyna, (except 12, 14-16 FLD, 13 FLD103), 84-15 Softail, (except 08 FXCW, 08-11 FXCWC, 88-03, 07-12, 14-15 FLSTC, 90-00, 03-12, 14-15 FLSTF, 93-96, 05, 07-12, 14-15 FLSTN, 08-10 FLSTSB, 10-12, 14-15 FLSTFB, 11-12 FXS, 11 FLSTSE2, 12 FLSTSE3, 12, 14-15 FLS, 13 FXS 103, 13-14 FXSBSE, 13 FLS 103, 13 FLSTC 103, 13 FLSTC 103 ANV, 13 FLSTF 103, 13 FLSTFB 103, 13 FLSTN103, 14-17 FXSB, 14-15 FLSTNSE, 16-17 FXSE, 86-90 FLST, 97-03 FLSTS, 01-06 FLSTCI, 01-06 FLSTFI, 01-03 FLSTSI, 05 FLSTFSE, 05-06 FLSTNI, 05-06 FLSTSCI, 06 FLSTFSE2, 06 FLSTI, 07 FLSTSC), 02-17 V-Rod	930195	930196	930203

NEW PRODUCTS



550036

550037

550038



930217



930219



930221



Knurled Rubber Footpegs

- High traction knurled rubber design
- CNC machined billet end cap w/ laser engraved Arlen Ness logo
- 1" longer than stock for added comfort and foot room
- Forged inner structure offers maximum strength

Unit: Pair , Qty.: 1

FITMENT

	BLACK ANODIZED PART#	BRASS PART#	CHROME PART#	GOLD ANODIZED PART#
21-24 Pan America, 20-21 LiveWire, 21-24 Sportster RH, 18-19, 23-24 FXBR, 18-20 FXBRS 114, 18 FXBRS 114 ANX, 18-20 FXFB, 18, 20 FXFBS 114, 18-20 FXLR, 18-20 FXBB, 18-24 FLSB, 19-20 FXDRS 114, 19 FXFB 114, 20-24 FXLRS, 20-24 FXST, 21-24 FXBBS, 21-22 FXBRS, 21-24 FXFBS, 22-24 FXLRST, 22 FXRST	930219		930217	930221
91-20 Sportster, (except 10-20 XL1200X, 11-20 XL1200C, 11-20 XL883L, 12-13, 15-16 XL1200V, 13 XL1200C ANV, 13-16 XL1200CA, 13-17 XL1200CB, 18 XL1200X ANX, 19-20 XL1200XS), 85-94 FX Model, 91-17 Dyna, (except 12, 14-16 FLD, 13 FLD103), 84-15 Softail, (except 08 FXCW, 08-11 FXCWC, 88-03, 07-12, 14-15 FLSTC, 90-00, 03-12, 14-15 FLSTF, 93-96, 05, 07-12, 14-15 FLSTN, 08-10 FLSTSB, 10-12, 14-15 FLSTFB, 11-12 FXS, 11 FLSTSE2, 12 FLSTSE3, 12, 14-15 FLS, 13 FXS 103, 13-14 FXSBSE, 13 FLS 103, 13 FLSTC 103, 13 FLSTC 103 ANV, 13 FLSTF 103, 13 FLSTFB 103, 13 FLSTN103, 14-17 FXSB, 14-15 FLSTNSE, 16-17 FXSE, 86-90 FLST, 97-03 FLSTS, 01-06 FLSTCI, 01-06 FLSTFI, 01-03 FLSTSI, 05 FLSTFSE, 05-06 FLSTNI, 05-06 FLSTSCI, 06 FLSTFSE2, 06 FLSTI, 07 FLSTSC, 02-17 V-Rod	550038	550036	550037	930216



930218



930220



930222



Knurled Rubber Passenger Pegs

- High traction knurled rubber design
- CNC machined billet end cap w/ laser engraved Arlen Ness logo
- 1" longer than stock for added comfort and foot room
- Forged inner structure offers maximum strength

Fitment: 18-24 Softail , Fitment Note: For OEM mount , Unit: Pair , Qty.: 1

FITMENT

	BLACK RUBBER, BLACK ENDCAP	BLACK RUBBER, CHROME ENDCAP	BLACK RUBBER, GOLD ENDCAP
18-24 Softail For OEM mount	930220		
18-24 Softail For OEM mount		930218	
18-24 Softail For OEM mount			930222



Speedliner Driver Floorboards

- Speedliner Floorboards feature CNC machined 3D knurled styling with specially formed oversized knurled rubber for increased foot grip with added cushion
- CNC Machined from Billet Aluminum
- Features a thin profile for added ground clearance during cornering
- Added length over stock for increased foot room
- Rubber Insert is specially formed to offer increased foot traction & reduce vibration

Unit: Pair , Qty.: 1

FITMENT	BLACK ANODIZED	CHROME	GOLD ANODIZED
18-21 FLSL, 18-20 FLDE, 18-21 FLHC, 18 FLHCS 114, 18 FLHCS 114 ANV, 18-20 FLFB, 18-20 FLFBS 114, 18 FLFBS 114 ANX, 18 FLFBS 114 ANV, 19-20 FLHC 114, 21-24 FLHCS, 21-24 FLFBS, 23 FLHCSANV, 23 FLFBSANV	923916	923917	
85-24 Touring, 09-24 Trike, 86-90 FLST, 88-03, 07-12, 14-17 FLSTC, 90-00, 03-12, 14-17 FLSTF, 93-96, 07-12, 14-17 FLSTN, 97-03 FLSTS, 01-06 FLSTCI, 01-06 FLSTFI, 01-03 FLSTSI, 05 FLSTFSE, 06 FLSTFSE2, 06 FLSTI, 06 FLSTNI, 06 FLSTSCI, 07 FLSTSC, 08-11 FLSTSB, 10-12, 14-17 FLSTFB, 10 FLSTSE, 11 FLSTSE2, 12, 14-17 FLS, 12 FLSTSE3, 13 FLS 103, 13 FLSTC 103, 13 FLSTC 103 ANV, 13 FLSTF 103, 13 FLSTFB 103, 13 FLSTN103, 14-15 FLSTNSE, 16-17 FLSS, 16-17 FLSTFBS, 12, 14-16 FLD, 13 FLD103, 80-84 FLT, 81-84 FLTC	923914	923915	930213



923908



923910



930223



Speedliner Brake and Shift Arm Control Kit

- Speedliner foot control kits are performance based foot controls that include a shift arm, brake arm, inner shift lever and shift rod
- 3D knurled billet design drastically enhances foot control styling while keeping an overall clean look
- Available with solo or heel/toe style shift levers
- Shift rod features specially designed spherical bearings hydraulically pressed in for an ultra clean look, eliminating the need for heim joints
- Each component is CNC machined from billet aluminum

Fitment: 00-24 Touring, 09-24 Trike , Fitment Note: For 00-07 models, adapter kit 930360 is needed , Unit: Kit , Qty.: 1

PART#	COLOR	DESCRIPTION
923908	Black, Anodized	with Heel/Toe Shifters
923910	Chrome	with Heel/Toe Shifters
930223	Gold, Anodized	with Heel/Toe Shifters
923911	Black	with Solo (Toe-) Shifter
923913	Chrome	with Solo (Toe-) Shifter
930224	Gold, Anodized	with Solo (Toe-) Shifter





Speedliner Passenger Floorboards

- Speedliner Passenger Floorboards feature a CNC machined 3D knurled design with specially formed oversized knurled rubber for increased foot grip with added comfort
- CNC machined from aircraft quality billet aluminum
- Designed to match Speedliner driver floorboards & the complete line of SpeedLiner accessories
- Rubber Insert is specially formed to offer increased foot traction & reduce vibration for the passenger
- Arlen Ness laser logo

Fitment: 85-24 Touring, 09-24 Trike, 84-17 Softail , Fitment Note: Fits Softail models with OEM floorboard mounting kit, except models with upper exhaust , Unit: Pair , Qty.: 1

PART#	COLOR
923918	Black, Anodized
923919	Chrome
930214	Gold, Anodized



Forged Highway Peg Mounts

- Low-profile design to blend in with the lines of the motorcycle
- CNC machined from billet aluminum
- Accepts HD type shifter pegs (5/16"-24)
- Swivel design allows pegs to be in the upright position when not in use
- Perfect for FLT Touring models with lower fairings
- Allows the use of any aftermarket or factory HD type shifter peg as a footrest

Unit: Pair , Qty.: 1

PART#	FIELD OF APPLICATION	BLACK ANODIZED	CHROME
930207	For 1-1/4" engine guards and accepts 5/16"-24 shifter pegs	930207	930208
930209	For 1-1/4" engine guards	930209	930210



Speedliner Brake Arm

- CNC machined from billet aluminum
- 3D knurled billet design with an overall clean look
- Drastically enhancement for your foot control styling
- Forged single piece brake arm for optimum strength and durability
- Includes a custom brake peg spacer that when installed extends the length of the brake peg for added leg clearance
- Easy bolt-on design

Fitment: 18-20 FXLR, 18-20 FXBB, 20-24 FXLRS, 20-24 FXST, 21-24 FXBBS, 22-24 FXLRST, 22 FXRST , Fitment Note: Fits models equipped with factory mid controls , Unit: Each , Qty.: 1

FITMENT

	BLACK Anodized	CHROME	GOLD Anodized
18-20 FXLR, 18-20 FXBB, 20-24 FXLRS, 20-24 FXST, 21-24 FXBBS, 22-24 FXLRST, 22 FXRST Fits models equipped with factory mid controls	930189	930190	930194



Speedliner Shift Lever

- CNC machined from billet aluminum
- 3D knurled billet design with an overall clean look
- Drastically enhancement for your foot control styling
- Forged single piece shift lever for optimum strength and durability
- Includes a custom shift peg spacer that when installed extends the length of the shift peg for added leg clearance
- Easy bolt-on design

Fitment: 18-20 FXLR, 18-20 FXBB, 20-24 FXLRS, 20-24 FXST, 21-24 FXBBS, 22-24 FXLRST, 22 FXRST , Fitment Note: Fits models equipped with factory mid controls , Unit: Each , Qty.: 1

PART# COLOR

930191	Black, Anodized
930192	Chrome
930193	Gold, Anodized



NEW PRODUCTS



924283



930211



930212



924283

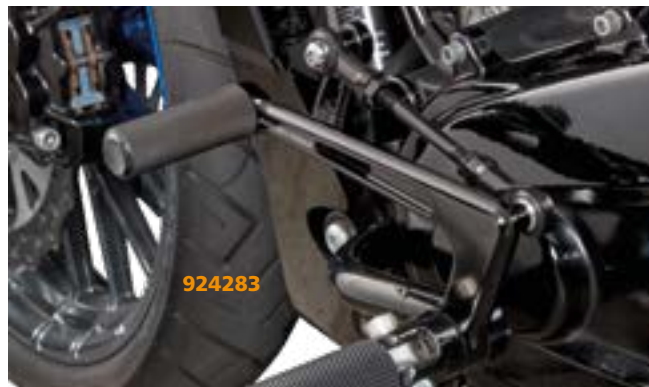

924283



Bagger Mid-Control Kit

- Mid Control foot control kits for FLT Touring / Bagger models
- Innovative design utilizes the factory floorboard mounts, allowing the mid controls to install in the factory foot control mounting locations on the frame
- The foot control mounting design allows for less vibration than other engine mounted mid control kits
- Mid control mounts are made from CNC bent steel tubing for maximum durability and increased ground clearance
- Shift and brake arms are CNC machined from billet aluminum
- Bolt-on installation for factory exhaust / headers and aftermarket pipes
- Extensive RD and road tested for smooth shifting and braking function
- Mid Control kits do not include footpegs, shift peg and brake peg, allowing the rider to add their preferred style or color pegs
- Accepts any male mount footpeg set and HD shift/brake peg

Unit: Kit , Qty.: 1

PART#	FITMENT	COLOR
924283	09-24 Touring, (except 23-24 FLHXSE, 23-24 FLTRXSE, 24 FLHX, 24 FLTRX, 24 FLTRXSTSE)	Black
930211	09-24 Touring, (except 23-24 FLHXSE, 23-24 FLTRXSE, 24 FLHX, 24 FLTRX, 24 FLTRXSTSE)	Chrome
930212	00-07 Touring	Black



- Converts Arlen Ness brake arms to fit on 2000-2007 FLT models
- CNC machined aluminum
- Includes mounting hardware
- Designed to fit: Deep Cut / 10-Gauge / Radius / SpeedLiner brake arm styles

Part#: 930360 , Fitment: 00-07 Touring , Color: Black Cut, Anodized , Unit: Each , Qty.: 1



917848, 917850

917849

930169

930170

929980

929981

929983

929982



Knurled Fusion Grips

- Knurled grip rubber
- Grip end is machined from billet aluminum and laser engraved with the Ness logo
- Grips include an installed throttle sleeve, grip glue, and simple to follow instructions

Color: Black , Bar ø: 1" , Unit: Pair , Qty.: 1

FITMENT	OPERATION TYPE	BLACK RUBBER, BLACK ENDCAP	BLACK RUBBER, BRASS ENDCAP	BLACK RUBBER, CHROME ENDCAP	BLACK RUBBER, GOLD ENDCAP
16-24 Softail, 11 FLSTSE2, 12 FLSTSE3, 13-14 FXSBSE, 14-15 FLSTNSE, 08-24 Touring, (except 23-24 FLHXSE, 23-24 FLTRXSE, 24 FLHX, 24 FLTRX, 24 FLTRXSTSE), 09-24 Trike, 16-17 FXDLS	Throttle By Wire	917850		917849	930170
23-24 FLHXSE, 23-24 FLTRXSE, 24 FLHX, 24 FLTRX, 24 FLTRXSTSE	Throttle By Wire	929980	929982	929981	929983
76-20 Sportster, 85-94 FX Model, 91-17 Dyna, (except 16-17 FXDLS), 84-15 Softail, (except 11 FLSTSE2, 12 FLSTSE3, 13-14 FXSBSE, 14-15 FLSTNSE), 85-07 Touring, 02-17 V-Rod, 76-84 FL Shovel, 76-84 FX Shovel Not for use with Handlebar Air Reservoir	Throttle Cables	917848			930169



917536, 917539, 990320, 990322



917537, 917540, 990321, 990323



929991



929990



929992



AirTrax Grips

- Air Trax grips feature an aggressive but comfortable rubber design that offers excellent hand traction while reducing vibration
- Grip end cap is CNC machined from billet aluminum
- Black rubber grips with various end caps available and laser-engraved Arlen Ness logo
- Matching foot and shift pegs available separately

Color: Black , Bar ø: 1" , Unit: Pair , Qty.: 1

FITMENT	OPERATION TYPE	BLACK RUBBER, BLACK ENDCAPS	BLACK RUBBER, BRASS ENDCAPS	BLACK RUBBER, CHROME ENDCAPS
08-24 Touring, (except 23 FLTRKSEANV, 23-24 FLHXSE, 23-24 FLTRXSE, 24 FLHX, 24 FLTRX, 24 FLTRXSTSE), 09-24 Trike, 16-24 Softail, 11 FLSTSE2, 12 FLSTSE3, 13-14 FXSBSE, 14-15 FLSTNSE, 16-17 FXDLS	Throttle By Wire	917539		917540
23-24 FLHXSE, 23-24 FLTRXSE, 24 FLHX, 24 FLTRX, 24 FLTRXSTSE	Throttle By Wire	929990	929992	929991
76-20 Sportster, 85-94 FX Model, 91-17 Dyna, (except 16-17 FXDLS), 84-15 Softail, (except 11 FLSTSE2, 12 FLSTSE3, 13-14 FXSBSE, 14-15 FLSTNSE), 85-07 Touring, 02-17 V-Rod, 76-84 FL Shovel, 76-84 FX Shovel Not for use with Handlebar Air Reservoir	Throttle Cables	917536		917537

NEW PRODUCTS



923926

923928

929987

923927

923929

929988

929989



Speedliner Grips

- SpeedLiner grips feature an oversized 3D knurled rubber design for comfort & dual integrated channels for increased grip
- CNC machined billet inner collar & end cap for custom style
- Excellent hand traction & comfort in all riding scenarios
- Arlen Ness laser logo included on each end cap
- New internal design installs like factory grips, no glue required for installation

FITMENT

Color: Black , Bar ø: 1" , Unit: Pair , Qty.: 1

	OPERATION TYPE	BLACK RUBBER, BLACK INNER COLLAR AND ENDCAP	BLACK RUBBER, CHROME INNER COLLAR AND ENDCAP	BLACK RUBBER, GOLD INNER COLLAR AND ENDCAP
08-24 Touring, (except 23 FLTRKSEANV, 23-24 FLHXSE, 23-24 FLTRXSE, 24 FLHX, 24 FLTRX, 24 FLTRXSTSE), 09-24 Trike, 16-24 Softail, 11 FLSTSE2, 12 FLSTSE3, 13-14 FXSBSE, 14-15 FLSTNSE, 16-17 FXDLS	Throttle By Wire	923928	923929	
23-24 FLHXSE, 23-24 FLTRXSE, 24 FLHX, 24 FLTRX, 24 FLTRXSTSE	Throttle By Wire	929987	929988	929989
76-20 Sportster, 85-94 FX Model, 91-17 Dyna, (except 16-17 FXDLS), 84-15 Softail, (except 11 FLSTSE2, 12 FLSTSE3, 13-14 FXSBSE, 14-15 FLSTNSE), 85-07 Touring, 02-17 V-Rod, 76-84 FL Shovel, 76-84 FX Shovel Not for use with Handlebar Air Reservoir	Throttle Cables	923926	923927	



923934

923937

929984

923935

923938

929985

930167

929986



Diamond Grips

- Diamond design rubber grips with integrated knurling inside each diamond shaped pocket for a vintage look with excellent hand traction
- Premium rubber grip feels soft & comfortable feel in all riding scenarios & will not wear easily
- CNC machined billet or brass end caps are available
- Arlen Ness® laser logo included on each custom end cap
- Available for both HD cable & throttle-by-wire models
- New grip tube design installs like factory grips, no glue required for simple & easy installation

Color: Black , Bar ø: 1" , Unit: Pair , Qty.: 1

FITMENT

	OPERATION TYPE	BLACK RUBBER, BLACK ENDCAP	BLACK RUBBER, CHROME ENDCAP	BLACK RUBBER, GOLD ENDCAP
08-24 Touring, (except 23 FLTRKSEANV, 23-24 FLHXSE, 23-24 FLTRXSE, 24 FLHX, 24 FLTRX, 24 FLTRXSTSE), 09-24 Trike, 16-24 Softail, 11 FLSTSE2, 12 FLSTSE3, 13-14 FXSBSE, 14-15 FLSTNSE, 16-17 FXDLS	Throttle By Wire	923937	923938	930168
23-24 FLHXSE, 23-24 FLTRXSE, 24 FLHX, 24 FLTRX, 24 FLTRXSTSE	Throttle By Wire	929984	929985	929986
76-20 Sportster, 85-94 FX Model, 91-17 Dyna, (except 16-17 FXDLS), 84-15 Softail, (except 11 FLSTSE2, 12 FLSTSE3, 13-14 FXSBSE, 14-15 FLSTNSE), 85-07 Touring, 02-17 V-Rod, 76-84 FL Shovel, 76-84 FX Shovel	Throttle Cables	923934	923935	930167



929993



929994



Deep Cut Comfort Grips

- Slightly larger diameter than factory
- Air cushion type rubber for increased comfort with less hand fatigue
- Conical grip body is forged from billet aluminum and CNC machined
- Less vibration due to Kraton air cushion type rubber

Bar ø: 1" , Unit: Pair , Qty.: 1

FITMENT	OPERATION TYPE	COLOR	PART#
08-24 Touring, (except 23 FLTRKSEANV, 23-24 FLHXSE, 23-24 FLTRXSE, 24 FLHX, 24 FLTRX, 24 FLTRXSTSE), 09-24 Trike, 16-24 Softail, 11 FLSTSE2, 12 FLSTSE3, 13-14 FXSBSE, 14-15 FLSTNSE, 16-17 FXDLS	Throttle By Wire	Black	930173
08-24 Touring, (except 23 FLTRKSEANV, 23-24 FLHXSE, 23-24 FLTRXSE, 24 FLHX, 24 FLTRX, 24 FLTRXSTSE), 09-24 Trike, 16-24 Softail, 11 FLSTSE2, 12 FLSTSE3, 13-14 FXSBSE, 14-15 FLSTNSE, 16-17 FXDLS	Throttle By Wire	Chrome	930172
23-24 FLHXSE, 23-24 FLTRXSE, 24 FLHX, 24 FLTRX, 24 FLTRXSTSE	Throttle By Wire	Black	929993
23-24 FLHXSE, 23-24 FLTRXSE, 24 FLHX, 24 FLTRX, 24 FLTRXSTSE	Throttle By Wire	Chrome	929994
76-20 Sportster, 85-94 FX Model, 91-17 Dyna, (except 16-17 FXDLS), 84-15 Softail, (except 11 FLSTSE2, 12 FLSTSE3, 13-14 FXSBSE, 14-15 FLSTNSE), 85-07 Touring, 02-17 V-Rod, 76-84 FL Shovel, 76-84 FX Shovel Not for use with Handlebar Air Reservoir	Throttle Cables	Black Anodized	930365
76-20 Sportster, 85-94 FX Model, 91-17 Dyna, (except 16-17 FXDLS), 84-15 Softail, (except 11 FLSTSE2, 12 FLSTSE3, 13-14 FXSBSE, 14-15 FLSTNSE), 85-07 Touring, 02-17 V-Rod, 76-84 FL Shovel, 76-84 FX Shovel Not for use with Handlebar Air Reservoir	Throttle Cables	Chrome	930171



930179



930185



925144



Method Hand Levers

- Forged billet aluminum
- CNC machined
- Performance inspired design
- Comfortable ergonomic shape
- Short length for quick and easy brake / clutch function
- Enhances style and feel of the hand controls
- Laser engraved Arlen Ness® logo
- Set includes brake and clutch hand levers

Unit: Set , Qty.: 1



FITMENT	OPERATION TYPE	BLACK ANODIZED	CHROME	GOLD ANODIZED
08-13 Touring, 14-16 FLHRC, 16 FLHR, (except 03 FLHRSEI, 04 FLHTCSE, 05 FLHTCSE2, 06 FLHTCUSE, 07 FLHRSE3, 07 FLHTCUSE2, 08 FLHRSE4, 08 FLHTCUSE3, 09 FLHTCUSE4, 09 FLTRSE3, 10 FLHTCUSE5, 10 FLHXSE, 11 FLTRUSE, 11 FLHXSE2, 11 FLHTCUSE6, 12 FLHTCUSE7, 12 FLHXSE3, 12 FLTRXSE, 13 FLHRSE5, 13 FLHTCUSE8, 13 FLTRXSE2, 13 FLTRXSE2 ANV)	Cable Clutch	925146	930176	930182
15-17 Softail, (except 16-17 FLSS, 16-17 FLSTFBS, 16-17 FXSE, 15 FLSTNSE)	Cable Clutch	925145	930175	930181
17-20 Touring, 17-20 Trike	Hydraulic Clutch	925148	930178	930184
18-24 Softail	Cable Clutch	925147	930177	930183
21-24 Touring, (except 23-24 FLHXSE, 23-24 FLTRXSE, 24 FLHX, 24 FLTRX, 24 FLTRXSTSE), 21-24 Trike	Cable Clutch	924948	930179	930185
96-03 Sportster, 96-17 Dyna, (except 07 FXDSE, 08 FXDSE2, 09 FXDFSE, 10 FXDFSE2), 96-14 Softail, (except 14 FLSTNSE, 13-14 FXSBSE, 04 FXSTDSE II, 05 FLSTFSE, 06 FLSTFSE2, 07 FXSTSSE, 08 FXSTSSE2, 09 FXSTSSE3, 10 FLSTSE, 11 FLSTSE2, 12 FLSTSE3), 96-07 Touring, (except 03 FLHRSEI, 04 FLHTCSE, 05 FLHTCSE2, 06 FLHTCUSE, 07 FLHRSE3, 07 FLHTCUSE2)	Cable Clutch	925144	930174	930180



Handlebar Reducing Sleeve Kit

- Riser adapter reducing sleeve from 32 mm (1 1/4") to 25,4 mm (1") or 28,6 mm (1 1/8")
- Fits Rick's Clubstyle Riser in combination with 1" or 1 1/8" handlebars
- 4 x aluminum half shells

Color: Black, Anodized , Unit: Each , Qty.: 1

PART#	FITMENT	DESCRIPTION	CLAMP Ø
925308	20-24 FXLRS, 22-24 FXLRST, 22 FXRST	1 1/4" to 1"	1"
930418		1 1/4" to 1 1/8"	1 1/8"



HIGHWAY HAWK

1" to 7/8" Handlebar Clamp Adaptor Sleeves

To make your 7/8" diameter handlebar fit to the existing 1" diameter handlebar clamps (risers).

Part#: 930497 , Bar ø: 7/8" , Clamp ø: 1" , Unit: Pack , Qty.: 1



Plug and Play Speedometer Extension Harness

- Plug and Play relocation of the speedometer when using risers up to 11.5"
- OE cable colors
- Preinsattled connectors and plugs
- Time-saving installation

Field of Application: Fits also Koso matching OE replacement speedometer , Unit: Each , Qty.: 1

PART#	FITMENT	DESCRIPTION	LENGTH MM
930416	20-24 FXLRS	80 cm / 31.5 Inches Long (S Models Round Instrument)	800
930417	22-24 FXLRST, 22 FXRST, 21-24 FXBBS, 20-24 FXST, 18-19, 22-24 FXBR, 18-20, 22 FXBRS 114, 18, 22 FXBRS 114 ANX, 18-20 FXBB, 21 FXBRS	65 cm / 26 Inches Long (Digital Instrument)	650



Bottom to Top Mount Round Speedometer Conversion Kit for Ricks Club Style Riser Kit

This kit contains everything to convert a Rick's Club Style Pullback S Riser Kit with Bottom Mount Round Speedometer to a Club Style Pullback S Riser Kit with TOP Mount Round Speedometer.

- Suitable for OEM speedometer of Low Rider S Models
- Adjustable angel of the speedometer housing
- Note: Speedometer not included

Part#: 930423 , Fitment: 20-24 FXLRS , Color: Black, Anodized , Unit: Kit , Qty.: 1



Club Style Pullback Riser Kit for Digital Speedometer

- Suitable for OEM digital speedometer of Low Rider ST, Softail Standard, Street-Bob (and Koso D2)
- Including handlebar clamp „Torque Bar“ for optimal stiffness
- Including riser screws and riser-rigid mounting kit with 4 x stainless steel bushings
- Clean look and no visible cables due to internal routing through covered cable cannels down the risers and cover on top of the triple clamp!

Color: Black, Anodized , Certification: With Approval , Clamp ø: 1 1/4" , Unit: Kit , Qty.: 1

PART#	FITMENT	DESCRIPTION
925088	22-24 FXLRST, 22 FXRST	7" Height, 1 1/4" Clamp Diameter
925089	22-24 FXLRST, 22 FXRST	8,5" Height, 1 1/4" Clamp Diameter
925090	22-24 FXLRST, 22 FXRST	10" Height, 1 1/4" Clamp Diameter
925091	22-24 FXLRST, 22 FXRST	11,5" Height, 1 1/4" Clamp Diameter
930544	18-20 FXBB, 20-24 FXST, 21-24 FXBBS	7" Height, 1 1/4" Clamp Diameter
930545	18-20 FXBB, 20-24 FXST, 21-24 FXBBS	8,5" Height, 1 1/4" Clamp Diameter
930546	18-20 FXBB, 20-24 FXST, 21-24 FXBBS	10" Height, 1 1/4" Clamp Diameter
930547	18-20 FXBB, 20-24 FXST, 21-24 FXBBS	11,5" Height, 1 1/4" Clamp Diameter



Club Style Pullback Riser Kit for Top Mount Round Speedometer

- Suitable for OEM speedometer of Low Rider S Models
- Adjustable angel of the speedometer housing
- Including handlebar clamp „Torque Bar“ for optimal stiffness
- Including riser screws and riser-rigid mounting kit with 4 x stainless steel bushings
- Clean look and no visible cables due to internal routing through covered cable cannels down the risers and cover on top of the triple clamp!
- Note: Fat Bob Models - Does not fit with OE Speedometer

Color: Black, Anodized , Certification: With Approval , Unit: Kit , Qty.: 1

PART#	FITMENT	DESCRIPTION
930419	22-24 FXLRS	7" Height, 1 1/4" Clamp Diameter
930420	22-24 FXLRS	8,5" Height, 1 1/4" Clamp Diameter
930421	22-24 FXLRS	10" Height, 1 1/4" Clamp Diameter
930422	22-24 FXLRS	11,5" Height, 1 1/4" Clamp Diameter
930536	18-20 FXFB, 18, 20 FXFBS 114, 19 FXFB 114, 21-24 FXFBS	7" Height, 1 1/4" Clamp Diameter
930537	18-20 FXFB, 18, 20 FXFBS 114, 19 FXFB 114, 21-24 FXFBS	8,5" Height, 1 1/4" Clamp Diameter
930538	18-20 FXFB, 18, 20 FXFBS 114, 19 FXFB 114, 21-24 FXFBS	10" Height, 1 1/4" Clamp Diameter
930539	18-20 FXFB, 18, 20 FXFBS 114, 19 FXFB 114, 21-24 FXFBS	11,5" Height, 1 1/4" Clamp Diameter



Club Style Pullback Riser Kit for Bottom Mount Round Speedometer

- Suitable for OEM speedometer of Low Rider S Models
- Adjustable angle of the speedometer housing
- Including handlebar clamp „Torque Bar“ for optimal stiffness
- Including riser screws and riser-rigid mounting kit with 4 x stainless steel bushings
- Clean look and no visible cables due to internal routing through covered cable cannels down the risers and cover on top of the triple clamp!
- Note: Fat Bob Models - Does not fit with OE Speedometer

Color: Black, Anodized , Certification: With Approval , Unit: Kit , Qty.: 1

PART#	FITMENT	DESCRIPTION
925092	22-24 FXLRS	7" Height, 1 1/4" Clamp Diameter
925093	22-24 FXLRS	8,5" Height, 1 1/4" Clamp Diameter
925094	22-24 FXLRS	10" Height, 1 1/4" Clamp Diameter
925095	22-24 FXLRS	11,5" Height, 1 1/4" Clamp Diameter
930532	18-20 FXFB, 18, 20 FXFBS 114, 19 FXFB 114, 21-24 FXFBS	7" Height, 1 1/4" Clamp Diameter
930533	18-20 FXFB, 18, 20 FXFBS 114, 19 FXFB 114, 21-24 FXFBS	8,5" Height, 1 1/4" Clamp Diameter
930534	18-20 FXFB, 18, 20 FXFBS 114, 19 FXFB 114, 21-24 FXFBS	10" Height, 1 1/4" Clamp Diameter
930535	18-20 FXFB, 18, 20 FXFBS 114, 19 FXFB 114, 21-24 FXFBS	11,5" Height, 1 1/4" Clamp Diameter



Club Style Pullback No Instrument Riser Kit (Models with Dash Mount Instruments)

- Suitable for models with fuel tank mounted instruments
- Including handlebar clamp „Torque Bar“ for optimal stiffness
- Including riser screws and riser-rigid mounting kit with 4 x stainless steel bushings
- Clean look and no visible cables due to internal routing through covered cable cannels down the risers and cover on top of the triple clamp!

Color: Black, Anodized , Certification: With Approval , Clamp ø: 1 1/4" , Unit: Kit , Qty.: 1

PART#	FITMENT	DESCRIPTION
925096	18-20 FXLR, 20-21 FXLRS	7" Height, 1 1/4" Clamp Diameter
925097	18-20 FXLR, 20-21 FXLRS	8,5" Height, 1 1/4" Clamp Diameter
925098	18-20 FXLR, 20-21 FXLRS	10" Height, 1 1/4" Clamp Diameter
925099	18-20 FXLR, 20-21 FXLRS	11,5" Height, 1 1/4" Clamp Diameter
930540	18-20 FXFB, 18, 20 FXFBS 114, 19 FXFB 114, 21-24 FXFBS	7" Height, 1 1/4" Clamp Diameter
930541	18-20 FXFB, 18, 20 FXFBS 114, 19 FXFB 114, 21-24 FXFBS	8,5" Height, 1 1/4" Clamp Diameter
930542	18-20 FXFB, 18, 20 FXFBS 114, 19 FXFB 114, 21-24 FXFBS	10" Height, 1 1/4" Clamp Diameter
930543	18-20 FXFB, 18, 20 FXFBS 114, 19 FXFB 114, 21-24 FXFBS	11,5" Height, 1 1/4" Clamp Diameter



Solid Riser Bushings

- Solid riser bushings for M8 Softtail models from 2018-up
- Recommended for 6", 8", or 10" Club Style risers
- High-strength aluminum
- CNC machined
- Kit contains 4 parts

Part#: 930288 , Fitment: 18-24 Softtail , Color: Black, Anodized , Unit: Pack , Qty.: 4



Riser Kit for Nightster RH975

- CNC-machined from billet aluminum
- Works with factory triple tree, gauge housing and cables/wiring harness
- Improved ergonomics for increased control and comfort
- Moves the factory handlebar and gauge assembly up and back towards the rider

Part#: 930166 , Fitment: 22-24 Nightster RH975 , Color: Black, Anodized , Unit: Kit , Qty.: 1



05846

631512

930188

05846

930187



Handlebar Damper Kit

- A must when changing to new handlebars or risers
- Eliminates flex while isolating vibration
- Proprietary polyurethane bushings
- Reduced vibration
- Add a more positive and rigid feel to your handlebar
- Heavy duty cup washers will not bend or distort like factory units
- Each kit includes polyurethane bushings, inner steel sleeves and heavy duty cup washers

Unit: Kit , Qty.: 1

FITMENT	BLACK COATED CUP WASHERS	CHROME CUP WASHERS
18-24 Softail, (except 19-20 FXDRS 114)	930187	924959
73-03 Sportster, 85-94 FX Model, 84-17 Softail, (except 88-03 FXSTS, 95-97 FXSTSB, 97, 99-03 FLSTS, 01-03 FLSTSI, 01-02, 04-06 FXSTSI, 05-06 FLSTSCI, 07 FLSTSC, 07 FXSTSSE, 08-11 FLSTSB, 08 FXSTSSE2, 09 FXSTSSE3), 76-84 FX Shovel, 73-84 FL Shovel, (except 80-84 FLT, 81-84 FLTC)	930186	05846
85-24 Touring, 09-24 Trike, 80-84 FLT, 81-84 FLTC	930188	631512

NEW PRODUCTS



Condenser

- Made only from the finest materials
- Designed for high quality and reliability

Unit: Each , Qty.: 1

PART#	FITMENT	FITMENT NOTE	OEM #
928087	58-69 Sportster		29534-55A
928088	30-52 Flathead, 36-47 Knucklehead, 48-65 Panhead, 66-78 FL Shovel, 71-78 FX Shovel, 54-78 Sportster	Except K models with magneto ignition	30801-47, 32726-30



Fuel Pressure Regulator for Touring (Magnet Marelli EFI)

- Made from finest materials
- Designed for high quality and reliability

Part#: 928089 , Fitment: 95-01 Touring , Fitment Note: Only for EFI models , OEM #: 27219-95 , Unit: Each , Qty.: 1

FITMENT	FITMENT NOTE	PART#
95-01 Touring	Only for EFI models	928089



928092



928094

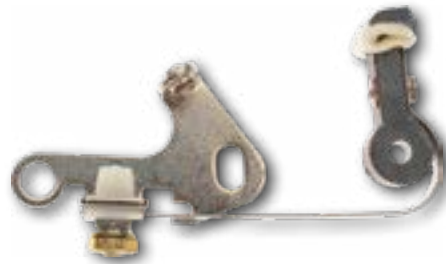

928093



Circuit Breaker

- Made only from the finest materials
- Designed for high quality and reliability

Unit: Set , Qty.: 1

FITMENT	FITMENT NOTE	OEM #	PART#
49-52 Flathead, 49-65 Panhead, 66-69 FL Shovel, 54-69 Sportster	Except K models, equipped with magneto ignition	30605-48	928092
58-69 Sportster	For models with magneto ignition	29533-55A	928094
71-78 Sportster, 70-78 FL Shovel, 71-78 FX Shovel		32661-70	928093



Flat Type 2 Pole Neoprene Molded Connector

This flat type 2 pole neoprene molded connector with 12", 18 gauge wire is ideal for connecting electrical systems.

- Pre-wired
- Ready to install
- Molded case
- All-round weather protection

Part#: 928098 , Field of Application: Universal , Unit: Set , Qty.: 1



Delco Type Voltage Regulator

- OEM equivalent electro-mechanical, voltage regulator
- For 12V Generator
- Heavy duty, shock mounted steel base
- Vibration resistant internal wire connections
- Large diameter contact surfaces
- Black enamel

Part#: 928099 , Fitment: 65 Panhead, 66-69 FL Shovel, 65-77 XLH , Color: Black , OEM #: 74510-64 , Unit: Each , Qty.: 1



17716

17715

895446



Stoptlight Switch

- Top quality hydraulic switch
- Heavy duty contacts
- Top quality brass terminals
- Reliable performance in the most severe environments

Unit: Each , Qty.: 1

PART#	FITMENT	OEM #
17716	79-20 Sportster, 68-84 FL Shovel, 71-84 FX Shovel, 85-94 FX Model, 84-23 Softail, 85-23 Touring, 02-17 V-Rod, 91-07 Dyna, 21-23 Sportster RH, (except 22-23 Nightster RH975, 23 Nightster Special RH975S), 21-23 Pan America	72023-51A
17715	58-65 Panhead, 66-68 FL Shovel, 51-73 Servi Car	72002-51A
895446	79-20 Sportster, 68-84 FL Shovel, 71-84 FX Shovel, 85-94 FX Model, 84-23 Softail, 85-23 Touring, 02-17 V-Rod, 91-07 Dyna, 21-23 Sportster RH, (except 22-23 Nightster RH975, 23 Nightster Special RH975S), 21-23 Pan America	72023-51D
928095	08-17 Dyna	72026-08A



17901

17902



25536

658444

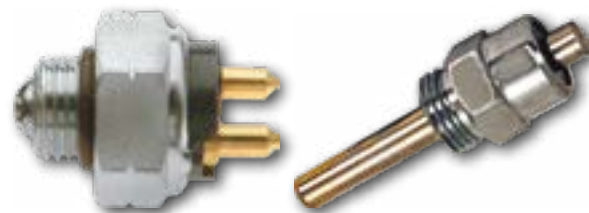

658445

84899



928090

928091



Transmission Neutral Switch

- Manufactured to very stringent specifications
- Proper function and long life in the toughest conditions
- Featuring hardened, high carbon steel stems
- Maximum wear resistance and durability

Unit: Each , Qty.: 1

PART#	FITMENT	OEM #
17901	71-78 FX Shovel	71507-71
17902	65 Panhead, 66-78 FL Shovel	71507-65
25536	59-64 Panhead, 86-98 Sportster, 87-94 FX Model, 91-97 Dyna, 87-97 Softail, 87-97 Touring, 97-98 M2, 97-98 S1, 97-98 S3	33900-59
658444	01-05 Dyna, 00-06 Softail, 01-06 Touring	33904-00
658445	98-00 Dyna, 98-99 Softail, 98-00 Touring, 02-17 V-Rod	33902-98
84899	79-84 FL Shovel, (except 80-84 FLT, 81-84 FLTC), 79-84 FX Shovel, (except 82-84 FXR, 82-84 FXRS, 83-84 FXRT, 84 FXRSDG), 85-86 FX Model, 84-86 Softail	33901-79
928090	99-20 Sportster, 99-02 M2, 99 S3, 99-02 X1, 03-10 XB	33900-99
928091	07-17 Dyna, 07-24 Softail, 07-24 Touring, (except 23-24 FLHXSE, 23-24 FLTRXSE, 24 FLTRXSTSE), 09-24 Trike	33926-06B



BLUE STREAK

Silicone Spark Plug Wire

- Copper Core plug wire set
- With improved electrical conductivity and mechanical strength
- These non resistive sets should only be used with points ignitions

Color: Black , Unit: Set , Qty.: 1

PART#	FITMENT	FIELD OF APPLICATION	OEM #
668330		For custom application multi-fit wireset	
668331	80-84 FL Shovel, 91-98 Dyna, 84-99 Softail		
668332	85-96 Touring		
668333	82-84, 89-94 FXR, 82-84, 89-92 FXRS, 83-84, 89-92 FXRT, 84 FXRSDG, 86, 89 FXRSL, 87 FXRC, 90-99 FXRS_CON, 90-93 FXRSSP		70187-82
668334	86-03 Sportster, (except 98-03 XL1200S)		31986-86, 31996-86
668335	97-98 Touring		31992-91
668336	99-08 Touring		31992-99
668337	99-17 Dyna		31960-99, 31981-99
668338	98-03 XL1200S		32043-98, 32044-98, 32045-98, 32046-98
668339	00-17 Softail, (except 08 FXCW, 08-11 FXCWC, 11-12 FXS, 13 FXS 103, 14-16 FXSB)		31983-00, 31981-99
668340		For custom application 4 plug multi-fit wireset	
668341	04-06 Sportster		31996-04
668342	07-20 Sportster, (except 08-10 XR1200, 10-13 XR1200X)		32003-07, 32006-07
895447	09-16 Touring, 09-16 Trike		32013-09, 32014-09
895448	09, 15 Victory Bagger, 09-15 Victory Cruiser, 09-15 Victory Touring		
895449	12-13 Indian Cruiser		N61100003
895450	15-17 Street		31600008, 31600009
928096	17-24 Touring, (except 23-24 FLHXSE, 23-24 FLTRXSE, 24 FLHX, 24 FLTRX, 24 FLTRXSTSE), 17-24 Trike	Set of 4 Cables	31600018, 31600023, 31600078, 31600079
928097	18-24 Softail, (except 19-20 FXDRS 114)	Set of 4 Cables	32001-08A, 31600081



**915777, 915778,
915779, 915780**

**915781, 915782,
915783, 915784**

**915785, 915786,
915787, 915788**

930154



Method™ Clear Series Air Cleaner

The Method® air cleaner designed by Arlen Ness motorcycles features a new Patent-Pending Oil Catch / Reservoir. To ensure no oil saturates the filter and restricts your airflow, the integrated oil catch collects any excess engine oil before it reaches the air filter. The Bolt-on design allows oil catch to be serviced when you service the filter element.

- Hard coated polycarbonate window
- Patented Design (US Patent: D852,680)
- Patented backing plate technology (US Patent: US 10,851,741 B1)
- CNC machined from forged billet aluminum
- Patented oil catch / reservoir
- Increases performance and mileage
- Eliminates oil blow-by on M8 engines
- Black pre-oiled performance air filter (Re-usable/washable)

Unit: Each , Qty.: 1

FITMENT	BLACK ANODIZED	BLACK CUT ANODIZED	CHROME	GOLD
16-17 Softail, 11 FLSTSE2, 12 FLSTSE3, 13-14 FXSBSE, 14-15 FLSTNSE, 08-16 Touring, 09-16 Trike, 16-17 FXDLS	915782	915778	915786	
18-24 Softail, 17-24 Touring, (except 23-24 FLHXSE, 23-24 FLTRXSE, 24 FLHX, 24 FLTRX, 24 FLTRXSTSE), 17-24 Trike	915781	915777	915785	930154
22-24 Nightster RH975, 23-24 Nightster Special RH975S	930148			
91-20 Sportster, (except 08-10 XR1200, 10-13 XR1200X) With CV Carburetor or Delphi EFI	915784	915780	915788	
99-17 Dyna, (except 16-17 FXDLS), 00-15 Softail, (except 11 FLSTSE2, 12 FLSTSE3, 13-14 FXSBSE, 14-15 FLSTNSE), 99-07 Touring, (except 99-01 FLHRCI, 99-01 FLHTCUI, 99-01 FLTRI, 00-01 FLHRI)	915783	915779	915787	



Mini 22 Air Cleaner

The Mini 22 Intake is a compact performance air cleaner that features a 4.5" tapered all-black filter design with an angled billet top for optimum leg clearance.

- 22° Angled Performance Filter design
- Patented hidden breather technology
- Utilizes our high flow velocity backing plate, used in both Monster Sucker & Velocity series air cleaners
- High performance black pre-oiled air filter designed for both form & function
- Increased Horsepower, torque & mileage
- Excellent Leg Room
- M8 applications include servo cover

Qty.: 1

FITMENT	BLACK	CHROME
08-16 Touring, 16-17 Softail, 11 FLSTSE2, 12 FLSTSE3, 13-14 FXSBSE, 14-15 FLSTNSE, 16-17 FXDLS	919444	919445
18-24 Softail, 17-24 Touring, (except 23-24 FLHXSE, 23-24 FLTRXSE, 24 FLHX, 24 FLTRX, 24 FLTRXSTSE), 17-24 Trike	919442	919443
22-24 Nightster RH975, 23-24 Nightster Special RH975S	930149	
91-20 Sportster, (except 08-10 XR1200, 10-13 XR1200X)	919448	919449
99-17 Dyna, (except 16-17 FXDLS), 00-15 Softail, (except 11 FLSTSE2, 12 FLSTSE3, 13-14 FXSBSE, 14-15 FLSTNSE), 99-07 Touring, (except 99-01 FLHRCI, 00 FLHRI, 99-01 FLHTCUI, 99-01 FLTRI)	919446	919447



Stage 2 Oval Upgrade Air Filter

- Stage 2 Oval Performance Air Filter Kits for factory oval HD air cleaners both increase performance and add style to the engine
- Features a performance filter with a pleated top to take in air from the sides and top of the filter for maximum airflow
- Filter cover, spacers and clamps are all CNC machined from billet aluminum
- Performance air filter is made from high-flow black pre-oiled cotton media
- Increased filter height specially designed to increase airflow without reducing leg room
- Over 50% more air filter surface area than paper filters found in factory oval air cleaners
- Dyno testing has shown up to a 3hp increase after installing the upgrade filter on factory displacement M8 engines; up to 5hp gain for 124" big bore M8 engines
- Each filter kit includes a performance filter, billet air cleaner cover, billet spacers and clamps
- Note: Requires OEM/HD (Ventilator®) Oval Backing Plate

Part#: 930147 , Fitment: 18-20 FLFBS 114, 18 FLFBS 114 ANX, 18 FLFBS 114 ANV, 18-20 FXBRS 114, 18 FXBRS 114 ANX, 21-24 FLFBS, 21-22 FXBRS, 22-24 FLHCS, 23 FLFBS ANV, 23 FLHCSANV , Field of Application: For oval Screaming Eagle ventilator air cleaners and M8 special / ST models equipped with HD oval ventilator air cleaner backing plates , Color: Black, Anodized , Unit: Kit , Qty.: 1



Air Cleaner Rain Sock

Rain sock's for Arlen Ness air cleaners will prevent water from getting to your filter and into the engine. Each pre-filter has been engineered to add an extra layer of protection from water and other debris without restricting airflow.

- Specially designed for Arlen Ness intakes
- Made in the USA
- 100% Monofilament polyester with water repellent finish
- Hydrophobic technology repels water in all weather conditions
- Deflects dirt and debris

Color: Black , Unit: Each , Qty.: 1

PART#	DESCRIPTION
654029	For Ness Big Sucker Stage I Air Cleaner
654030	For Ness Big Sucker Stage II Air Cleaner
930150	For Inverted and Method Air Cleaners
930151	For Monster Sucker Air Cleaners
930152	For Velocity 65° and 90° Intakes
930153	For Mini 22 Air Cleaner



Horn Kit

- High performance horn kit
- CNC machined from forged billet aluminum
- Features a horn capable of 110 dB to make sure you are heard on the road
- Stainless steel mesh insert

Unit: Kit , Qty.: 1

FITMENT TEXT	BLACK	BLACK CUT	CHROME
07-20 Sportster		930142	930143
91-94 FX Model, 91-17 Dyna, 91-24 Softtail, 91-24 Touring, 09-24 Trike	930144		930141



10-Gauge Cam Cover

- Machined from 6061 T-6 forged aluminum
- Replaces OEM die-cast cam cover
- Includes necessary gaskets and hardware

Unit: Each , Qty.: 1

FITMENT

01-17 Dyna, 01-17 Softail, 01-16 Touring, (except 01 FLHRCI, 01 FLHRI, 01 FLHTCUI, 01 FLTRI), 09-16 Trike

18-24 Softail, 17-24 Touring, (except 23-24 FLHXSE, 23-24 FLTRXSE, 24 FLHX, 24 FLTRX, 24 FLTRXSTSE), 17-24 Trike

	BLACK ANODIZED	BLACK CUT ANODIZED	CHROME
01-17 Dyna, 01-17 Softail, 01-16 Touring, (except 01 FLHRCI, 01 FLHRI, 01 FLHTCUI, 01 FLTRI), 09-16 Trike	930161	654193	654192
18-24 Softail, 17-24 Touring, (except 23-24 FLHXSE, 23-24 FLTRXSE, 24 FLHX, 24 FLTRX, 24 FLTRXSTSE), 17-24 Trike	930162	915715	915714



10-Gauge Rocker Box Cover

- Carved from 6061 T-6 forged billet aluminum
- Drastically changes the look of your engine
- Replaces OEM top rocker box covers
- Includes necessary gaskets and hardware

Qty.: 1

FITMENT

18-24 Softail, 17-24 Touring, 17-24 Trike

99-17 Dyna, 00-17 Softail, 99-16 Touring, 09-16 Trike

	BLACK ANODIZED	BLACK CUT ANODIZED	CHROME
18-24 Softail, 17-24 Touring, 17-24 Trike	930160	915767	915766
99-17 Dyna, 00-17 Softail, 99-16 Touring, 09-16 Trike	930159	654191	654190



550006



550007



930157



915712



915713



930158



10-Gauge Transmission Top Cover

- Machined from billet aluminum
- Includes necessary gasket and hardware
- Black and chrome finish

Unit: Each , Qty.: 1

FITMENT

	BLACK ANODIZED	BLACK CUT ANODIZED	CHROME
06-17 Dyna, 07-17 Softail, 07-16 Touring, 09-16 Trike	930157	550007	550006
18-24 Softail, 17-24 Touring, (except 23-24 FLHXSE, 23-24 FLTRXSE, 24 FLHX, 24 FLTRX, 24 FLTRXSTSE), 17-24 Trike	930158	915713	915712



654198



654199



930155



654200



654201



10-Gauge Transmission Side Cover

- Carved from 6061 T-6 billet aluminum
- Replaces OEM cover
- Includes necessary gaskets and hardware
- Matching transmission top covers sold separately

Unit: Each , Qty.: 1

FITMENT

	OPERATION TYPE	BLACK ANODIZED	BLACK CUT ANODIZED	CHROME
07-24 Softail, (except 09 FXSTSSE3, 10 FLSTSE, 11 FLSTSE2, 12 FLSTSE3, 13-14 FXSBSE, 14-15 FLSTNSE, 16-17 FXSE, 16-17 FLSS, 16-17 FLSTFBS), 06-17 Dyna, 07-13, 21-24 Touring, 14-16 FLHRC, 16 FLHR, (except 07 FLHRSE3, 07 FLHTCUSE2, 08 FLHRSE4, 08 FLHTCUSE3, 09 FLHTCUSE4, 09 FLTRSE3, 10 FLHTCUSE5, 10, 23-24 FLHXSE, 11 FLTRUSE, 11 FLHXSE2, 11 FLHTCUSE6, 12 FLHTCUSE7, 12 FLHXSE3, 12, 23-24 FLTRXSE, 13 FLHRSE5, 13 FLHTCUSE8, 13 FLTRXSE2, 13 FLTRXSE2 ANV, 24 FLHX, 24 FLTRX, 24 FLTRXSTSE), 09-13, 21-24 Trike	Cable Clutch	930155	654199	654198
14-20 Touring, (except 14-16 FLHRC, 16 FLHR), 14-20 Trike	Hydraulic Clutch	930156	654201	654200



NEW PRODUCTS



930137



918224



918226



930138



10-Gauge Derby Cover

- Machined from 6061-T6 billet aluminum
- 10-Gauge styling
- Chrome hardware included and gasket
- Matching 10-Gauge Point Cover and other accessories are available separately

Unit: Each , Qty.: 1

FITMENT

	BLACK ANODIZED	BLACK CUT ANODIZED	CHROME	GOLD ANODIZED
16-24 Touring, 15 FLHTKL, 15 FLHTCUL, 16-24 Trike	930137	918224	918226	930138
99-17 Dyna, 00-18 Softail, (except 18 FLSB), 99-15 Touring, (except 15 FLHTKL, 15 FLHTCUL)	930139	918223	918222	930140



930131



930132



930133

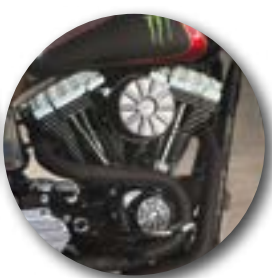

930134



930135



930136



918220, 918221



10-Gauge Point Cover

- CNC machined from billet aluminium
- Chrome mounting hardware included

Unit: Each , Qty.: 1

FITMENT

FITMENT	DESCRIPTION	BLACK ANODIZED	BLACK CUT ANODIZED	CHROME	GOLD ANODIZED
18-24 Softail, 18-24 Touring, (except 23-24 FLHXSE, 23-24 FLTRXSE, 24 FLHX, 24 FLTRX, 24 FLTRXSTSE), 17-24 Trike	2-hole	930131	918220	930132	930133
99-17 Dyna, 00-17 Softail, 99-16 Touring, 09-16 Trike	5-hole	930134	918221	930135	930136



EZ-Install Type Pushrod Set

EZ-Install pushrods can be installed without removing gas tanks or rocker boxes. Stock pushrods can be cut and removed easily. If you are using bolt-in cams, this is a big plus! These pushrods are a great match for all Andrews camshafts. Aluminum pushrods are lighter while the chrome-moly steel pushrods are more rigid for high performance. Aluminium types are made in anodized aluminum.

Sold in Sets

PART#	FITMENT
24575	85-94 FX Model, 91-98 Dyna, 84-99 Softail, 85-98 Touring
24576	85-94 FX Model, 91-98 Dyna, 84-99 Softail, 85-98 Touring
24577	99-17 Dyna, 00-17 Softail, 99-16 Touring, 09-16 Trike
24578	99-17 Dyna, 00-17 Softail, 99-16 Touring, 09-16 Trike
930247	18-24 Softail, 17-24 Touring



Adjustable Pushrods

Andrews Products pushrods using stock diameter tubing so there is no cover tube interference. Aluminum pushrods are lighter while the chrome-moly steel pushrods are more rigid for high performance.

Sold in Sets

PART#	FITMENT
24249	85-94 FX Model, 91-98 Dyna, 84-99 Softail, 85-98 Touring
24339	85-94 FX Model, 91-98 Dyna, 84-99 Softail, 85-98 Touring
24595	91-20 Sportster, 97-02 M2, 97-98 S1, 97-99 S3, 99-02 X1, 03-10 XB
930248	86-90 Sportster
930245	66-84 FL Shovel, 71-84 FX Shovel
930246	66-84 FL Shovel, 71-84 FX Shovel



Lifter Cover Set

Direct OE replacement
Including gaskets and screw kit
Set with front and rear lifter cover

Fitment: 18-24 Softail, 17-24 Touring, 17-24 Trike , Unit: Pair , Qty.: 1

PART#	COLOR	OEM #
928117	Black	25700890
928118	Chrome	25700410,25700411





Camshaft for Milwaukee Eight

Milwaukee 8 bikes are available in both 107 and 114 cubic inch engine sizes. With high efficiency four-valve heads, M8 engines show great potential for performance gains especially with new design Andrews M8 series camshafts.

Keep in mind, cam timing specs for four valve heads look very different from camshafts designed for two valve applications. Engines with four valve heads have much greater flow efficiency so cam timing durations are a lot shorter.

Unit: Each , Qty.: 1

PART#	FITMENT	FITMENT NOTE	DESCRIPTION	DISPLACEMENT
900600	18-24 Softtail, 17-23 Touring, (except 23 FLHXSE, 23 FLTRXSE), 17-18 Trike	With stock valve springs	Bolt in cam, more torque for riding with 107 inches engines, rapid torque rise (1000-5500 RPM)	1745 ccm (107 cui)
900601	18-24 Softtail, 17-24 Touring, (except 23-24 FLHXSE, 23-24 FLTRXSE, 24 FLHX, 24 FLTRX, 24 FLTRXSTSE), 17-24 Trike	With stock valve springs	More power from stock engines (1000-5800 RPM), Max.Torque=112 ft.lbs.@3440RPM, Max. Power=96HP@5360 RPM	1745 ccm (107 cui), 1868 ccm (114 cui), 1923 ccm (117 cui)
918046	18-24 Softtail, (except 22-24 FXLRST, 22 FXRST, 22-24 FXLRS, 23-24 FXBR), 17-24 Touring, (except 23-24 FLHXSE, 23-24 FLTRXSE, 22-23 FLHXST, 22-23 FLTRXST, 23 FLTRKSEANV, 24 FLHX, 24 FLTRX, 24 FLTRXSTSE), 17-24 Trike	With stock valve springs	Bolt in cam, 107-114 inches. Big power (127 ft. lbs. and 109 HP (from 1200 to 5500 RPM)	1745 ccm (107 cui), 1868 ccm (114 cui)
900602	18-24 Softtail, (except 22-24 FXLRST, 22-24 FXLRS, 22 FXRST, 23-24 FXBR), 17-24 Touring, (except 23-24 FLHXSE, 23-24 FLTRXSE, 22-23 FLHXST, 22-23 FLTRXST, 23 FLTRKSEANV, 24 FLHX, 24 FLTRX, 24 FLTRXSTSE), 17-24 Trike	With high lift valve springs	More torque and power for bigger engines 114 inches and all around riding (1500-5700 RPM)	1745 ccm (107 cui), 1868 ccm (114 cui)
900603	18-24 Softtail, 17-24 Touring, (except 23-24 FLHXSE, 23-24 FLTRXSE, 24 FLHX, 24 FLTRX, 24 FLTRXSTSE), 17-24 Trike	For bigger than 114 CUI engines, with high lift valve springs	More torque and power for modified engines (1600-5500 RPM). For bigger cubic inches.	
919916	18-24 Softtail, 17-24 Touring, (except 23-24 FLHXSE, 23-24 FLTRXSE, 24 FLHX, 24 FLTRX, 24 FLTRXSTSE), 17-24 Trike	With high lift valve springs	The cam for 117, 124, 143 engines. More torque and power through entire RPM range (1600-5500).	1923 ccm (117 cui), 2035 ccm (124 cui), 2061 ccm (126 cui)
930289	18-24 Softtail, 17-24 Touring, (except 23-24 FLHXSE, 23-24 FLTRXSE, 24 FLHX, 24 FLTRX, 24 FLTRXSTSE), 17-24 Trike	With high lift valve springs	The cam for 117,124,143 engines. More torque and power through entire RPM range (1600-5500).	1923 ccm (117 cui), 2035 ccm (124 cui), 2343 ccm (143 cui)



Transmission for 6 Speed Twin Cam A

Ultima's® 6-SPEED Transmissions are the ultimate upgrade for the early model Twin Cam A engines. These transmission cases are designed to be a stronger stock replacement case. They are packed with new features that meet or exceed standards expected of much higher priced transmissions.

- Gears and shafts made from hardened 8620 steel giving you years of service with big inch engines
- Pro-cut lead-in ramps for positive shifting
- Hardened steel forks for durability and longevity
- Roller detent gives you smooth, positive shifting action
- Billet trap door
- Transmission case machined from permanent mold A356-T6 Aluminum
- Close ratio 2.94 low gear set
- Assembled by professionals and bench tested
- Improved spring material composition
- Cable operated clutch release
- Designed to use OEM style speedometer sensors
- Extended oil filler cast into case to allow clearance for longer starters

Fitment: 01-05 Dyna, 01-06 Touring , Unit: Each , Qty.: 1

PART#	DESCRIPTION
924998	Black Housing, Chrome Covers
924999	Raw Housing, Chrome Covers



Power Clutch 2.0

The combination of adjustments to the Power Clutch and the additional new "Clutch Control" offers the best possible clutch performance. No slipping, no problems when adjusting and a properly separating clutch - This update solves all the challenges of the M8 models and offers outstanding smoothness.

- Improved performance
- Replaces OEM part
- Reduces clutch lever force by an average up to 45-50%
- Easier to adjust
- Improved pressure point
- Kit includes "Müller clutch control"

Part#: 930521 , Fitment: 21-24 Touring, 18-24 Softail, 21-24 Trike , Operation Type: Cable Clutch , Unit: Each , Qty.: 1



Clutch Control

The Müller Motorcycle Clutch Control replaces the plastic part that connects the lower cable to the gearbox and the upper part of the clutch cable to the lever in the original. The aluminum Müller Motorcycle Clutch Control is more precisely adjustable and does not wear out like the OE part.

Part#: 930522 , Fitment: 21-24 Touring, 18-24 Softail, 21-24 Trike , Operation Type: Cable Clutch , Unit: Each , Qty.: 1



ABS Wheel Bearing

- ABS wheel bearing for factory wheel sizes and custom conversions
- Custom conversion bearings available for 21", 23" and 26" wheels
- Eliminate ABS malfunction and warning lights when using oversized wheels
- Sold each

Fitment: 14-20 Sportster, 12-17 Dyna, 11-24 Softail, 09-24 Touring, 19-24 Trike, 08-17 V-Rod, 21-24 Sportster RH, 21-24 Pan America , Diameter: 52 mm, Axle ø: 25 mm , Unit: Each , Qty.: 1

PART#	FITMENT NOTE	DESCRIPTION	OEM #
930235	Trike only front	For Stock Wheel Size	9252
930366	Use only in 21" front wheel conversions	For 21" Front Wheels	
930367	Use only in 23" front wheel conversions	For 23" Front Wheels	
930368	Use only in 26" front wheel conversions	For 26" Front Wheels	



631098, 631099, 631100



1" Lowered Kickstand

Lowered design corrects angle of kickstand on lowered bikes to ensure bike is secure and will not fall over.

- A must when lowering your motorcycle
- 1" shorter than factory kickstand
- Made from forged steel
- Fits factory kickstand mount
- Accept factory kickstand spring

Color: Chrome , Unit: Each , Qty.: 1

PART#	FITMENT
631098	84-06 Softail
631099	07-24 Touring
930244	99-17 Dyna



642902



642901



925167



925168



World's Finest Products For Harley-Davidsons

Engine Guard with Highway Pegs

Achieve a cool look and added comfort on your rides with these engine guards. They allow you to stretch your legs while providing a secure foothold on the integrated footrests.

- Includes mounting Hardware

Qty.: 1

FITMENT

	BLACK	CHROME
00-03, 07-11, 14-17 FLSTC, 00, 03-05, 07-12, 14-17 FLSTF, 00-03 FLSTS, 01-05 FLSTCI, 01-05 FLSTFI, 01-03 FLSTSI, 05, 07-12, 14-17 FLSTN, 05 FLSTNI, 05 FLSTSCI, 05 FLSTFSE, 07 FLSTSC, 08-09, 11 FLSTSB, 06 FLSTFSE2, 10-12, 14-17 FLSTFB, 10 FLSTSE, 11 FLSTSE2, 12, 14-17 FLS, 12 FLSTSE3, 13 FLS 103, 13 FLSTC 103, 13 FLSTC 103 ANV, 13 FLSTF 103, 13 FLSTFB 103, 13 FLSTN103, 14-15 FLSTNSE, 16-17 FLSS, 16-17 FLSTFBS	642902	642901
18-23 Softail, (except 19-20 FXDRS 114)	925168	925167

NEW PRODUCTS



Front Highway Bar

Reproductions of the original equipment bars constructed from 1-1/4" steel tubing and available in either a chrome-plated or gloss black powder coated finish. Hardware included.

- Includes mounting Hardware

Qty.: 1

FITMENT	PART#	PART#
	BLACK	CHROME
00-03, 07-12, 14-17 FLSTC, 00-03 FLSTS, 00, 03-12, 14-17 FLSTF, 01-06 FLSTCI, 01-03 FLSTSI, 01-06 FLSTFI, 05 FLSTFSE, 05, 07-12, 14-17 FLSTN, 05-06 FLSTSCI, 05-06 FLSTNI, 06 FLSTFSE2, 06 FLSTI, 07 FLSTSC, 08-11 FLSTSB, 10-12, 14-17 FLSTFB, 10 FLSTSE, 11 FLSTSE2, 12 FLSTSE3, 13 FLSTC 103, 13 FLSTC 103 ANV, 13 FLSTF 103, 13 FLSTFB 103, 13 FLSTN103, 14-15 FLSTNSE, 16-17 FLSTFBS	642912	642911
00-03 FXSTS, 00-03, 07 FXST, 00-03, 05, 07 FXSTD, 00-03, 07-09 FXSTB, 01-02, 04, 06 FXSTBI, 01-02, 04-06 FXSTSI, 01-06 FXSTDI, 01-02, 04-06 FXSTI, 07-10 FXSTC, 07 FXSTSSE, 08 FXSTSSE2, 09 FXSTSSE3, 11-12 FXS, 13 FXS 103, 13-14 FXSBSE, 14-17 FXSB, 16-17 FXSE	642906	642905
09-24 Touring, (except 24 FLHX, 24 FLTRX, 23-24 FLHXSE, 23-24 FLTRXSE, 24 FLTRXSTSE), 09-24 Trike	642898	642897
18-24 Softail, (except 19-20 FXDRS 114)	925170	925169
72-84 FX Shovel, 85 FXWG, 84-89, 99 FXST, 87-98 FXSTC, 89-99 FXSTS, 95-97 FXSTSB, 98-99 FXSTB	642909	
86-87 FLST, 88-99 FLSTC, 90-95, 97-99 FLSTF, 93-96 FLSTN, 97-99 FLSTS	642908	642907
97-08 Touring	642900	642899



Rear Saddlebag Guards

Reproductions of the Original Equipment bars constructed from steel tubing and available in either a chrome-plated or gloss black powder coated finish.

- Includes mounting Hardware

Fitment: 00-03, 07-12, 14-17 FLSTC, 00-03, 05, 07-09 FXSTB, 00-03, 07, 11-15 FXST, 00-03 FXSTS, 08-10 FXSTC, 12, 14-17 FLS, 11-12 FXS, 13 FLSTC 103, 13 FLSTC 103 ANV, 13 FLS 103, 13 FXS 103, 16-17 FLSS, 04-06 FLSTCI, 04-06 FXSTI, 04-06 FXSTSI, 04, 06 FXSTBI, **Fitment Note:** For models, equipped with saddlebags, relocation kit is needed, OEM #: 49261-00A, Unit: Kit, Qty.: 1

PART#	COLOR
925173	Chrome
925174	Black



Chrome Engine Guard with Footrests

This highway bar and footrest combination was designed with the riders comfort in mind. They are constructed of 1.25" steel tubing and chrome-plated with the addition of a heavy-duty rubber foot pad. They are perfect for those long rides when you want to stretch your legs while on the road.

Color: Chrome , Unit: Each , Qty.: 1

PART#	FITMENT
610367	86-87 FLST, 88-99 FLSTC, 90-95, 97-99 FLSTF, 93-96 FLSTN, 97-99 FLSTS
610369	97-08 Touring, (except 99-03, 07-08 FLTR, 99-06 FLTRI)
610370	09-24 Touring, (except 09 FLTR, 09 FLTRSE3, 10, 13, 18-24 FLTRX, 11, 15-16 FLTRUSE, 12, 18-19, 21-24 FLTRXSE, 13, 16-19 FLTRU, 13 FLTRXSE2, 13 FLTRXSE2 ANV, 15-23 FLTRXS, 20-24 FLTRK, 22-23 FLTRXST, 22 FLTRKSE, 23 FLTRKSEANV, 23-24 FLHXSE, 24 FLHX, 24 FLTRXSTSE), 09-24 Trike, (except 23-24 FLTRT)



Curved Engine Guard

- Retro style engine guard
- Perfect protection with nice shaped curves
- Includes mounting set

Fitment: 00-03, 07-12, 14-17 FLSTC, 00-03 FLSTS, 00, 03-12, 14-17 FLSTF, 01-06 FLSTCI, 01-03 FLSTSI, 01-06 FLSTFI, 05 FLSTFSE, 05, 07-12, 14-17 FLSTN, 05-06 FLSTSCI, 05-06 FLSTNI, 06 FLSTFSE2, 06 FLSTI, 07 FLSTSC, 08-11 FLSTSB, 10-12, 14-17 FLSTFB, 10 FLSTSE, 11 FLSTSE2, 12 FLSTSE3, 13 FLSTC 103, 13 FLSTC 103 ANV, 13 FLSTF 103, 13 FLSTFB 103, 13 FLSTN103, 14-15 FLSTNSE, 16-17 FLSTFBS , Unit: Each , Qty.: 1

PART#	COLOR
642903	Chrome
642904	Black



925171



925172



Chopped Front Highway Bar

Achieve a sophisticated and lowered appearance for your custom bagger with the chopped engine guard. This guard combines a sleek, streamlined look with optimal functionality, providing a distinctive twist to your bike's style.

Includes mounting Hardware

Fitment: 16-22 FLHR, 15-18, 20-21, 23 FLHXS, 18-24 FLHRXS, 14, 18-23 FLHX, 18 FLHX ANV, 18 FLHXS ANX, 22 FLHX , Fitment Note: Does not fit with lower fairings , Unit: Kit , Qty.: 1

PART#	COLOR	OEM #
925171	Chrome	49000105
925172	Black	49000114



Low Boy Fork Lowering Kit

- Lowers front fork 1 1/4" or 2" depending on the spacer used
- Simple installation with only minor disassembly of forks necessary
- Easy to return to stock
- Progressively wound springs

Field of Application: Careful evaluation of fender-to-frame clearance is required when installing any lowering kit. , Qty.: 1

PART#	FITMENT	FITMENT NOTE	DESCRIPTION	DIAMETER MM	UNIT
28470	80-84 FL Shovel, 86-13 Touring, (except 02-03 FLHT, 02 FLHTC, 02, 04-05 FLHTCI, 02-05 FLHTCUI, 02-03 FLTR, 02-05 FLTRI, 03-04 FLHTI, 04 FLHTCSE, 05 FLHTCSE2), 84-17 Softail, (except 88-03 FXSTS, 95-97 FXSTSB, 97-03 FLSTS, 01-03 FLSTSI, 01-02, 04-06 FXSTSI, 05-06 FLSTSCI, 07 FLSTSC, 07 FXSTSSE, 08-11 FLSTSB, 08 FXCV, 08-11 FXCWC, 08 FXSTSSE2, 09 FXSTSSE3, 13-14 FXSBSE, 14-17 FXSB, 16-17 FXSE), 93-03 FXDWG, 02 FXDWGSE3, 04-05 FXDWGI, 80-84 FXWG		-1.25"/-2" Lower, 41 mm	41	Kit
28471	88-20 Sportster, (except 08-10 XR1200, 10-13 XR1200X, 16-20 XL1200X, 16-20 XL1200CX, 18 XL1200X ANX, 19-20 XL1200XS), 87-94 FX Model, 91-05 Dyna, (except 93-03 FXDWG, 99-03 FXDX, 01-03 FXDXT, 02 FXDWGSE3, 04-05 FXDWGI, 04-05 FXDXI)	For use with 39mm Showa forks	-1.25"/-2" Lower, 39 mm	39	Kit
28472	84-87 Sportster, 85-87 FX Model, 84 FXE, 84 FXEF, 84 FXR, 84 FXRS, 84 FXRSDG, 84 FXRT, 84 FXSB	Except L87 Models with 39mm Fork.	-1.25"/-2" Lower, 35 mm	35	Kit
928198	17-24 Touring, (except 23-24 FLHXSE, 23-24 FLTRXSE, 24 FLTRXSTSE)		-1.25"/-2" Lower, 49 mm	49	Pair



Linear Rate Lowering Fork Spring Kit

These kits, when combined with shorter than stock rear shocks, will give you that low, custom look. Comes complete with Fork Springs, spacers, and instructions. For a 1" or 2" low configuration for most models.

Part#: 928199 , Fitment: 17-23 Touring, (except 23 FLHXSE, 23 FLTRXSE) , Fitment Note: 17-19 FLHTKL only lowers 1" 17-19 FLHTKL only lowers 1" , Diameter: 49 mm, Unit: Pair , Qty.: 1



930236

930239



Gold or Black 49 mm Fork Tubes

- 49mm black or gold coated fork tubes for FLT Touring or M8 Softtail models
- Available in factory length and +2" extended length for riders looking to increase ground clearance
- Designed to work with both factory and aftermarket front suspension internals and fork legs
- Choose from black or gold color finish

Unit: Pair , Qty.: 1

FITMENT	DESCRIPTION	BLACK	GOLD
17-24 Touring, (except 23-24 FLHXSE, 23-24 FLTRXSE, 24 FLTRXSTSE) Aftermarket suspension internals require the use of 17-up FLT fitment performance kits / cartridges	22-7/8" (Stock Length)	930237	930236
17-24 Touring, (except 23-24 FLHXSE, 23-24 FLTRXSE, 24 FLTRXSTSE) Aftermarket suspension internals require the use of 17-up FLT fitment performance kits / cartridges	24-1/4" (+2" Over)	930239	930238
18-24 Softail, (except 18-24 FLSB, 18-20 FXFB, 18, 20 FXFBS 114, 19-20 FXDRS 114, 19 FXFB 114, 20-24 FXLRS, 21-24 FXFBS, 22-24 FXLRST, 22 FXRST)	23-3/4" (Stock Length)	930241	930240
18-24 Softail, (except 18-24 FLSB, 18-20 FXFB, 18, 20 FXFBS 114, 19-20 FXDRS 114, 19 FXFB 114, 20-24 FXLRS, 21-24 FXFBS, 22-24 FXLRST, 22 FXRST)	25-3/4" (+2" Over)	930243	930242



Method No Flex Fork Legs

- Performance based design
- Elevates style and handling of FLT Touring models
- CNC machined from aircraft quality billet aluminum
- Integrated „No Flex“ fork brace for adding rigidity and stability
- CNC machined fender and brake caliper mounts
- Billet 12-point style axle nuts
- Dual disc, choose from factory (axial) or radial style caliper mounts
- Brake caliper mounts designed for factory size 11.8" diameter brake rotors and will accept up to 14" oversized rotors
- Radial caliper mounts are 100mm bolt pattern
- Designed for 18" to 21" front wheels (21" front wheels require custom fender / fork brace spacers)
- Accepts both factory and aftermarket performance suspension internals
- Includes set of fork seals and billet dust seal covers

Color: Black , Unit: Kit , Qty.: 1

PART#	FITMENT	DESCRIPTION
930551	14-24 Touring, (except 23-24 FLHXSE, 23-24 FLTRXSE, 24 FLTRXSTSE, 24 FLHX, 24 FLTRX)	For Factory Axial Dual Brakes
930973	24 FLHX, 24 FLTRX	For Factory Axial Dual Brakes
930552	14-24 Touring, (except 23-24 FLHXSE, 23-24 FLTRXSE, 24 FLTRXSTSE)	For Radial Dual Brakes (100mm bolt pattern)



Method Fork Guards for Baggers

- Performance inspired fork guards
- Feature a lightweight design
- Exposed view to the sides of the fork tubes for a unique look
- Protecting the front of Bagger fork tubes from road debris
- High quality finish fits all styles from performance bagger to big wheel bagger
- CNC machined from 6061-T6 billet aluminum
- Replaces OEM lower fork covers on FLT Touring / Bagger Models
- Designed to work with factory or aftermarket lower fork legs
- Look great with gold or all black coated fork tubes
- Includes new set of fork seals
- Sold in pairs

Fitment: 14-24 Touring, (except 23-24 FLHXSE, 23-24 FLTRXSE, 24 FLTRXSTSE) , Unit: Pair , Qty.: 1

PART#	COLOR
930362	Black
930363	Chrome
930364	Gold



928171



928172



928174



World's Finest Products For Harley-Davidsons

LED Fuel Gauge

Replacement for OE analog Fuel Gauges.

- Clean and modern look
- Plug and play

Unit: Each , Qty.: 1

FITMENT	OEM #	BLACK	CHROME
01-03 FLSTCI, 01-03 FLSTFI, 01-03 FLSTSI, 01-02 FXSTBI, 01-03 FXSTDI, 01-02 FXSTI, 01-02 FXSTSI, 03 FXSTDSE, 01-03 FLHRCI, 01-02 FLHRI, 02 FLHRSEI	75099-01A	928174	928173
09-17 Dyna, 08-17 Softail, (except 11-12 FXS, 13-14 FXSBSE, 13 FXS 103, 14-17 FXSB, 16-17 FXSE), 08-10, 13, 16-21 FLHR, 08-18 FLHRC, 18-24 FLHRXS, 22 FLHX , 15-24 FLRT	75241-08	928172	928171



919462



919463



919464



930145



10-Gauge Gas Cap

- 10-Gauge CNC machined billet aluminum gas caps with ratcheting design
- Each top is CNC machined from solid billet aluminum
- Exclusive ratchet design provides proper closure torque & design alignment
- Sold individually
- Fitment: 97-up Vented
- Laser engraved Arlen Ness logo
- All Black anodize or chrome finish

Fitment: 96-19 Sportster, 96-17 Dyna, 97-03, 07-10, 13, 16-19 FLHR, 97, 00-02, 04-06 FLHRI, 98-06 FLHRCI, 02-03 FLHRSEI, 04-06 FLHRSI, 07-18 FLHRC, 07 FLHRS, 07 FLHRSE3, 08 FLHRSE4, 13 FLHRSE5, 14 FLHRSE, 18-19 FLHRXS , **Fitment Note:** 19 Models only in Case the OEM Fuel Cap does NOT have a notch in the Bottom Part. , **Description:** Vented , **Unit:** Each , **Qty.:** 1

PART#	COLOR
919462	Black, Anodized
919463	Chrome
919464	Contrast Cut
930145	Gold, Anodized



919467



919468



930146



12 Point Gas Cap

- 12 Point Gas Caps features a race inspired design made to accent stainless 12 point hardware
- Each top is CNC machined from solid billet aluminum
- Exclusive ratchet design provides proper closure torque & design alignment
- Sold individually
- Fitment: 97-up Vented
- Laser engraved Arlen Ness logo & „Race Gas Only“
- Black Anodized or Chrome finish

Fitment: 96-19 Sportster, 96-17 Dyna, 97-03, 07-10, 13, 16-19 FLHR, 97, 00-02, 04-06 FLHRI, 98-06 FLHRCI, 02-03 FLHRSEI, 04-06 FLHRSI, 07-18 FLHRC, 07 FLHRS, 07 FLHRSE3, 08 FLHRSE4, 13 FLHRSE5, 14 FLHRSE, 18-19 FLHRXS , **Fitment Note:** 19 Models only in Case the OEM Fuel Cap does NOT have a notch in the Bottom Part. , **Unit:** Each , **Qty.:** 1

PART#	COLOR
919467	Black, Anodized
919468	Chrome
930146	Gold, Anodized



05889



654116



Radius Oil Pressure Gauge Kit

- Constantly monitor oil pressure to ensure maximum performance and long lasting reliability
- Glass lens, filled with vibration dampening glycerin for lasting performance
- Billet bracket mounts oil pressure gauge to the rear rocker box
- Includes gauge, billet bracket/cone, stainless steel hose assembly and necessary hardware

Diameter: 38.1 mm, Unit: Kit , Qty.: 1

FITMENT	DESCRIPTION	BLACK	CHROME
85-94 FX Model, 91-98 Dyna, 84-99 Softail, 94-98 FLHR, 98 FLHRCI		05897	654117
99-17 Dyna, 00-17 Softail, 99-03, 07-10, 13, 16 FLHR, 99-06 FLHRCI, 00-02, 04-06 FLHRI, 02-03 FLHRSEI, 04-06 FLHRSI, 07-16 FLHRC, 07 FLHRS, 07 FLHRSE3, 08 FLHRSE4, 13 FLHRSE5, 14 FLHRSE		654116	05889
99-17 Dyna, 00-17 Softail, 99-03, 07-10, 13, 16 FLHR, 99-06 FLHRCI, 00-02, 04-06 FLHRI, 02-03 FLHRSEI, 04-06 FLHRSI, 07-16 FLHRC, 07 FLHRS, 07 FLHRSE3, 08 FLHRSE4, 13 FLHRSE5, 14 FLHRSE	With Ness Logo, Chrome		930163



Method Oil Pressure Gauge Kit

- Oil pressure gauge kits that allow you to monitor your engines oil pressure in all riding conditions
- CNC machined billet aluminum gauge bracket
- Oil gauge features a stainless steel gauge housing and glass lens
- Gauge is filled with vibration dampening glycerin for easy viewing when riding
- Braided stainless steel oil hose for a performance look
- Mounts to the factory / OEM rear rocker box
- Note: Does not fit with aftermarket Rocker-Box-Covers

Fitment: 18-24 Softail, 17-24 Touring, (except 23-24 FLHXSE, 23-24 FLTRXSE, 24 FLTRXSTSE), 17-24 Trike , Fitment Note: Does not fit with aftermarket rocker box covers, except Touring models equipped with factory oil pressure gauges , Description: for M8 Softail and Touring , Unit: Kit , Qty.: 1

PART#	COLOR
930164	Chrome
930165	Black



check our dealer store | www.custom-chrome-europe.com





World's Finest Products For Harley-Davidsons



NEW PRODUCTS



929993

929993

929994

929994



929987

929988

929989

929984



929985

929986

929990

929991



929992

929980

929981

929982



929983



Grips for 2024 and 23 CVO Touring Models

Fitment: 23-24 FLHXSE, 23-24 FLTRXSE, 24 FLHX, 24 FLTRX, 24 FLTRXSTSE , Operation Type: Throttle By Wire , Bar ø: 1" , Unit: Pair , Qty.: 1

DESIGN	DESCRIPTION	PART#	DESIGN	DESCRIPTION	PART#
AirTrax	Black Rubber, Black Endcaps	929990	Knurled Fusion	Black Rubber, Black Endcap	929980
AirTrax	Black Rubber, Brass Endcaps	929992	Knurled Fusion	Black Rubber, Brass Endcap	929982
AirTrax	Black Rubber, Chrome Endcaps	929991	Knurled Fusion	Black Rubber, Chrome Endcap	929981
Deep Cut Comfort	Black Anodized Aluminium, Black Rubber Inserts	929993	Knurled Fusion	Black Rubber, Gold Endcap	929983
Deep Cut Comfort	Chromed Aluminium, Black Rubber Inserts	929994	Speedliner	Black Rubber, Black Inner Collar and Endcap	929987
Diamond	Black Rubber, Black Endcap	929984	Speedliner	Black Rubber, Chrome Inner Collar and Endcap	929988
Diamond	Black Rubber, Chrome Endcap	929985	Speedliner	Black Rubber, Gold Inner Collar and Endcap	929989
Diamond	Black Rubber, Gold Endcap	929986			



929365



929366



Dash A Dashboard Indicator

Almost invincible when turned off, but unbeatable in action: Thanks to the mounting position under the handlebars, the new Dash indicators virtually disappear visually at the front of the motorcycle. At the same time, the Kellermann Dash indicators offer maximum brightness with minimum size. This means that the credo of Kellermann's compact indicators now also applies to the new generation of dashboard indicators: „sensationally small - spectacularly bright“.

The optimized light control of the new Dash family is also achieved by a sophisticated system of lenses and reflectors. The Kellermann HighPower LED** and EXtranz® - Extreme Optical Transparency technology are used here.

The complete electronics of the Dash A Dark are in the casing, this indicator can be plugged into the 12 volt net directly.*

* Possibly electronic equipment is needed to regulate the flashing rate.

** Combination out of the IC operated Longlife Protection Guard® system with high-performance-LEDs latest type of construction.

- Sensationally small, spectacularly bright
- EXtranz® - Extreme Optical Transparency Technology
- Kellermann HighPower LED Technology
- Longlife Protection Guard®, IC operated, 330 kHz
- High quality metal housing
- Suitable for 12 volt DC applications
- European design protection
- Dimensions: 31 x 23 x 13 mm
- ECE-tested for front

Fitment: 18-24 Softail , Color: Black , Certification: E-Approved , Unit: Each , Qty.: 1

PART#	DESCRIPTION
929365	Front Left
929366	Front Right



929367



929368



929368



929367



Dash M Dashboard Indicator

Almost invincible when turned off, but unbeatable in action: Thanks to the mounting position under the handlebars, the new Dash indicators virtually disappear visually at the front of the motorcycle. At the same time, the Kellermann Dash indicators offer maximum brightness with minimum size. This means that the credo of Kellermann's compact indicators now also applies to the new generation of dashboard indicators: „sensationally small - spectacularly bright“.

The optimized light control of the new Dash family is also achieved by a sophisticated system of lenses and reflectors. The Kellermann HighPower LED** and EXtranz® - Extreme Optical Transparency technology are used here.

The complete electronics of the Dash M Dark are in the casing, this indicator can be plugged into the 12 volt net directly.*

* Possibly electronic equipment is needed to regulate the flashing rate.

** Combination out of the IC operated Longlife Protection Guard® system with high-performance-LEDs latest type of construction.

- Sensationally small, spectacularly bright
- EXtranz® - Extreme Optical Transparency Technology
- Kellermann HighPower LED Technology
- Longlife Protection Guard®, IC operated, 330 kHz
- High quality metal housing
- Suitable for 12 volt DC applications
- European design protection
- Dimensions: 45 x 23 x 13 mm
- ECE-tested for front

Fitment: 18-24 Softail , Color: Black , Certification: E-Approved , Unit: Each , Qty.: 1

PART#	DESCRIPTION
929367	Front Left
929368	Front Right



Anarchy Semifairing

Enhance your custom motorcycle's look with the Anarchy Semifairing. Constructed from highly impact-resistant materials with excellent aerodynamic properties. Compatible with Harley-Davidson and Indian motorcycles. Designed specifically for each motorcycle model, ensuring a perfect fit to the headlight shape. Combines sportiness and protection. Provides an extreme look while protecting both the motorcycle and the rider. Easy to install with the model related bracket kit containing instructions and necessary hardware. All bracket kits in conjunction with the Anarchy Semifairing are approved by the German KBA.

The Approval Document is valid for the following Models: 15-20 XL1200X, 19-20 XL1200XS, 18-20 FXLR, 18-20 FXBB, 21-24 FXBBS, 07-17 FXDB, 15-20 XG750, 17-24 Scout, 17-20, 23-24 Scout Sixty

Certification: With Approval , Qty.: 1

DESCRIPTION	COLOR	FITMENT	PART#
Semifairing without Bracket; Height 385 mm x Width 250 mm	Flat Black	15-20 Street, (except 18-20 XG750A), 18-20 FXLR, 18-20 FXBB, 20-24 FXST, 21-24 FXBBS, 16-20 XL1200X, 18 XL1200X ANX, 19-20 XL1200XS, 06 FXDBI, 07-17 FXDB, 14 FXDBB, 16 FXDBC, 15-24 Scout, 16-20, 23-24 Scout Sixty	930254
Semifairing without Bracket; Height 385 mm x Width 250 mm	Gloss Black	15-20 Street, (except 18-20 XG750A), 18-20 FXLR, 18-20 FXBB, 20-24 FXST, 21-24 FXBBS, 16-20 XL1200X, 18 XL1200X ANX, 19-20 XL1200XS, 06 FXDBI, 07-17 FXDB, 14 FXDBB, 16 FXDBC, 15-24 Scout, 16-20, 23-24 Scout Sixty	929690
Bracket		06 FXDBI, 07-17 FXDB, 14 FXDBB, 16 FXDBC	929702
Bracket		15-20 Street, (except 18-20 XG750A)	929699
Bracket		15-24 Scout, 16-20, 23-24 Scout Sixty	929703
Bracket		16-20 XL1200X, 18 XL1200X ANX, 19-20 XL1200XS	929701
Bracket		18-20 FXLR	929700
Bracket		21-24 FXBBS	930258



Batwing SML Fairing

Enhance your custom motorcycle's design with the Batwing SML fairing, featuring a sleek black ABS plastic shell. The clear PMMA screens are available in two different heights. Easy to install with the model related bracket kit containing instructions and necessary hardware. All bracket kits in conjunction with the Batwing SML Windsshield are approved by the German KBA. Select the screen of your choice.

The Approval Document is valid for the following Models: 09-20 XL883N, 15-20 XL1200X, 19-20 XL1200XS, 18-20 FXLR, 18-20 FXBB, 21-24 FXBBS, 07-17 FXDB, 15-20 XG750, 17-24 Scout, 17-20, 23-24 Scout Sixty, 18-24 Scout Bobber, 23-24 Scout Bobber Sixty

- How to order Santee Batwing SML Fairings:
 1. Choose Fairing
 2. Select the matching bracket
 3. Add your choice of screen

Certification: With Approval , Qty.: 1

DESCRIPTION	COLOR	FITMENT	PART#
Fairing without Screen and Bracket; Height 345 mm x Width 490 mm	Flat Black	15-20 Street, (except 18-20 XG750A), 09-12 XL1200N, 09-20 XL883N, 16-20 XL1200X, 18 XL1200X ANX, 19-20 XL1200NS, 19-20 XL1200XS, 06 FXDBI, 07-17 FXDB, 14 FXDBB, 16 FXDBC, 18-20 FXLR, 18-20 FXBB, 20-24 FXST, 21-24 FXBBS, 23-24 Nightster Special RH975S, 15-24 Scout, 16-20, 23-24 Scout Sixty, 18-24 Scout Bobber, 21-24 Scout Bobber Twenty, 23-24 Scout Bobber Sixty	930255
Fairing without Screen and Bracket; Height 345 mm x Width 490 mm	Gloss Black	15-20 Street, (except 18-20 XG750A), 09-12 XL1200N, 09-20 XL883N, 16-20 XL1200X, 18 XL1200X ANX, 19-20 XL1200NS, 19-20 XL1200XS, 06 FXDBI, 07-17 FXDB, 14 FXDBB, 16 FXDBC, 18-20 FXLR, 18-20 FXBB, 20-24 FXST, 21-24 FXBBS, 23-24 Nightster Special RH975S, 15-24 Scout, 16-20, 23-24 Scout Sixty, 18-24 Scout Bobber, 21-24 Scout Bobber Twenty, 23-24 Scout Bobber Sixty	929691
Bracket		06 FXDBI, 07-17 FXDB, 14 FXDBB, 16 FXDBC	929708
Bracket		09-20 XL883N, 09-12 XL1200N, 19-20 XL1200NS	929704
Bracket		15-20 Street, (except 18-20 XG750A)	929705
Bracket		15-24 Scout, 16-20, 23-24 Scout Sixty	929709
Bracket		16-20 XL1200X, 18 XL1200X ANX, 19-20 XL1200XS	929707
Bracket		18-20 FXBB, 20-24 FXST, 21-24 FXBBS	929711
Bracket		18-20 FXLR	929706
Bracket		18-24 Scout Bobber, 21-24 Scout Bobber Twenty, 23-24 Scout Bobber Sixty	929710
Screen; Sport; Height 45 mm x Width 370 mm	Clear		929724
Screen; Sport; Height 45 mm x Width 370 mm	Tinted		929725
Screen; Touring; Height 145 mm x Width 370 mm	Clear		929726
Screen; Touring; Height 145 mm x Width 370 mm	Tinted		929727



Dark Night Semifairing

For those seeking a sporty fairing for their custom motorcycle, whether it's a Harley-Davidson or Indian motorcycle, the Dark Night fairing is the ideal choice. The Sporty Design features a sleek and a striking appearance, while ensuring the best driving experience. It adapts seamlessly to the headlight shapes. Easy to install with the model related bracket kit containing instructions and necessary hardware. All bracket kits in conjunction with the Dark Night Semifairing are approved by the German KBA. Select the screen of your choice.

The Approval Document is valid for the following Models: 15-20 XG750, 07-17 FXDB, 15-20 XL1200X, 19-20 XL1200XS, 18-20 FXLR, 18-20 FXBB, 21-24 FXBBS, 17-24 Scout, 17-20, 23-24 Scout Sixty, 18-24 Scout Bobber, 23-24 Scout Bobber Sixty

- How to order Santee Dark Night Fairings:
 1. Choose Fairing
 2. Select the matching bracket
 3. Add your choice of screen

Description: Dimensions Fairing with Screen, Height 470 mm x Width 460 mm , Certification: With Approval , Qty.: 1

DESCRIPTION	COLOR	FITMENT	PART#
Semifairing without Bracket and Screen	Flat Black	15-20 Street, (except 18-20 XG750A), 16-20 XL1200X, 18 XL1200X ANX, 19-20 XL1200XS, 06 FXDBI, 07-17 FXDB, 14 FXDBB, 16 FXDBC, 18-20 FXLR, 18-20 FXBB, 20-24 FXST, 21-24 FXBBS, 15-24 Scout, 16-20, 23-24 Scout Sixty, 18-24 Scout Bobber, 21-24 Scout Bobber Twenty, 23-24 Scout Bobber Sixty	930257
Semifairing without Bracket and Screen	Gloss Black	09-20 XL883N, 09-12 XL1200N, 19-20 XL1200NS	929692
Semifairing without Bracket and Screen	Gloss Black	15-20 Street, (except 18-20 XG750A), 16-20 XL1200X, 18 XL1200X ANX, 19-20 XL1200XS, 06 FXDBI, 07-17 FXDB, 14 FXDBB, 16 FXDBC, 18-20 FXLR, 18-20 FXBB, 20-24 FXST, 21-24 FXBBS, 15-24 Scout, 16-20, 23-24 Scout Sixty, 18-24 Scout Bobber, 21-24 Scout Bobber Twenty, 23-24 Scout Bobber Sixty	929693
Bracket		06 FXDBI, 07-17 FXDB, 14 FXDBB, 16 FXDBC	929717
Bracket		09-20 XL883N, 09-12 XL1200N, 19-20 XL1200NS	929713
Bracket		15-20 Street, (except 18-20 XG750A)	929714
Bracket		15-24 Scout, 16-20, 23-24 Scout Sixty	929718
Bracket		16-20 XL1200X, 18 XL1200X ANX, 19-20 XL1200XS	929716
Bracket		18-20 FXBB, 20-24 FXST, 21-24 FXBBS	929720
Bracket		18-20 FXLR	929715
Bracket		18-24 Scout Bobber, 21-24 Scout Bobber Twenty, 23-24 Scout Bobber Sixty	929719
Screen	Dark Tinted		929729
Screen	Tinted		929728



929694/929742

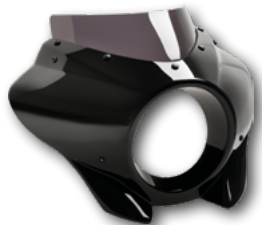

929695/929739



929742



929737



929738



929739



929740



929741



Mirage Semifairing

Upgrade your custom motorcycle with the Dark Night semi-fairing, perfect for Harley-Davidson and Indian motorcycles. With enhanced driving experience it adapts perfectly to your headlight. Easy to install with the model related bracket kit containing instructions and necessary hardware. All bracket kits in conjunction with the Mirage Semifairing are approved by the German KBA. Select the screen of your choice.

The Approval Document is valid for the following Models: 18-20 FXBB, 21-24 FXBBS

- How to order Santee Mirage Fairings:
 - 1. Choose Fairing
 - 2. Select the matching bracket
 - 3. Add your choice of screen

Certification: With Approval , Qty.: 1

DESCRIPTION	COLOR	FITMENT	PART#
Semifairing without Bracket and Screen; Height 400 mm x Width 530 mm	Flat Black	18-20 FXBB, 20-24 FXST, 21-24 FXBBS, 23-24 Nightster Special RH9755	929694
Semifairing without Bracket and Screen; Height 400 mm x Width 530 mm	Gloss Black	18-20 FXBB, 20-24 FXST, 21-24 FXBBS, 23-24 Nightster Special RH9755	929695
Bracket		18-20 FXBB, 20-24 FXST, 21-24 FXBBS	929722
Screen; Sport; Height 60 mm x Width 280 mm	Clear		929737
Screen; Sport; Height 60 mm x Width 280 mm	Dark Tinted		929739
Screen; Sport; Height 60 mm x Width 280 mm	Tinted		929738
Screen; Touring; Height 160 mm x Width 280 mm	Clear		929740
Screen; Touring; Height 160 mm x Width 280 mm	Dark Tinted		929742
Screen; Touring; Height 160 mm x Width 280 mm	Tinted		929741

NEW PRODUCTS



929736



929732



929731



929733



929735



929734



929730



Fury Semifairing

Enhance the Harley-Davidson Sportster S with the Fury Semifairing for improved aerodynamics and a personalized look. Batwing style inspired by white sharks, perfectly integrates with the motorcycle's tank. Reduces air impact on the rider, minimizing turbulence and fatigue. Made from durable ABS plastic and 4 mm thick CN acrylic screens (must be purchased separately), offering high resistance to impacts and aging. Available in matte black or glossy black. Matching screens are available as Sport (aggressive and minimalist) and Touring (better protection), available in clear, tinted, dark tinted, and black (only Sport screen). Easy to install with the model related bracket kit containing instructions and necessary hardware. All bracket kits in conjunction with the Fury Semifairing are approved by the German KBA. Select the screen of your choice.

The Approval Document is valid for the following Models: 21-24 Sportster S RH1250S

- How to order Santee Fury Fairings:
 1. Choose Fairing
 2. Select the matching bracket
 3. Add your choice of screen

Certification: With Approval , Qty.: 1

DESCRIPTION	COLOR	FITMENT	PART#
Semifairing without Bracket and Screen; Height 370 mm x Width 550 mm	Flat Black	21-24 Sportster S RH1250S	929696
Semifairing without Bracket and Screen; Height 370 mm x Width 550 mm	Gloss Black	21-24 Sportster S RH1250S	929697
Bracket		21-24 Sportster S RH1250S	929721
Screen; Sport; Height 65 mm x Width 350 mm	Black		929733
Screen; Sport; Height 65 mm x Width 350 mm	Clear		929730
Screen; Sport; Height 65 mm x Width 350 mm	Dark Tinted		929732
Screen; Sport; Height 65 mm x Width 350 mm	Tinted		929731
Screen; Touring; Height 115 mm x Width 350 mm	Clear		929734
Screen; Touring; Height 115 mm x Width 350 mm	Dark Tinted		929736
Screen; Touring; Height 115 mm x Width 350 mm	Tinted		929735



929743



929744



929745



929746



929747



929748



929749



929744



Replacement Windscreen for Low Rider ST

The Santee Replacement windscreens for Low Rider ST enhance the aerodynamic protection of your motorcycles with original semi-fairings, perfectly complementing their aesthetic. Available in Sport (238 mm) and Touring (385 mm) versions, riders can select the best fit for their needs. Wind tunnel-designed, these screens tilt closer to the rider, reducing frontal air impact, eliminating turbulence and helmet vibrations, and significantly increasing comfort and reducing fatigue. The Sport version reduces aerodynamic pressure by 30%, while the Touring version achieves a 47% reduction. Manufactured from 4 mm thick acrylic, these screens are highly impact-resistant and transparent. Their rounded edges enhance safety and meet stringent standards like the German regulations. Installation is straightforward, requiring no mechanical expertise. Fits to the OEM mounting points!

The Approval Document is valid for the following Models: 22-24 FXLRST

Fitment: 22-24 FXLRST , Certification: With Approval , Unit: Each , Qty.: 1

PART#	GLASS COLOR	DESCRIPTION
929747	Tinted	Touring; Height 385 mm x Width 500 mm
929748	Dark Tinted	Touring; Height 385 mm x Width 500 mm
929749	Clear	Touring; Height 385 mm x Width 500 mm
929743	Tinted	Sport; Height 238 mm x Width 480 mm
929744	Dark Tinted	Sport; Height 238 mm x Width 480 mm
929745	Clear	Sport; Height 238 mm x Width 480 mm
929746	Black	Sport; Height 238 mm x Width 480 mm

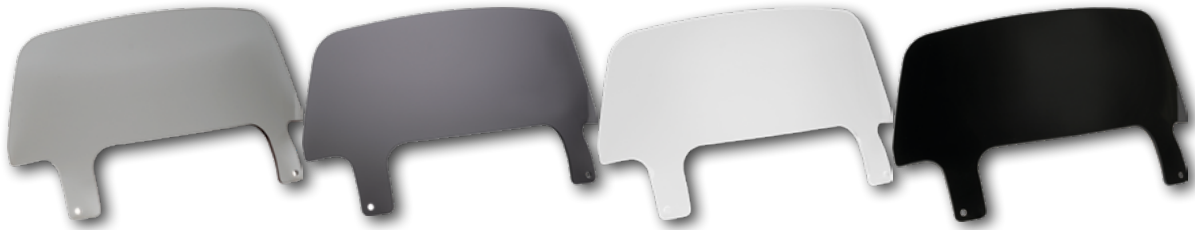

929750

929751

929752

929753

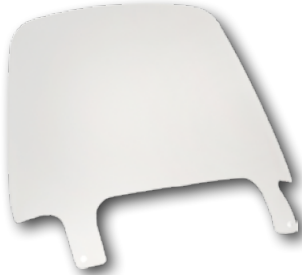

929756



929754



Replacement Windscreen for Sport Glide

The Replacement windscreen for Softail Sport Glide provide enhanced aerodynamic protection for your motorcycles with original semi-fairings, perfectly complementing their aesthetics. The windscreens come in two versions: Sport (150 mm) and Touring (250 mm). The wind tunnel-tested design directs airflow away from the rider, reducing turbulence and helmet vibrations, significantly increasing riding comfort. The Sport version decreases aerodynamic pressure by 30%, while the Touring version achieves a 47% reduction. Manufactured in Europe from 4 mm thick acrylic, the windscreens are highly impact-resistant. Their rounded edges enhance safety and meet strict standards such as the German regulations. Installation is simple and requires no mechanical knowledge. Fits to the OEM mounting points!

The Approval Document is valid for the following Models: 18-24 FLSB

Fitment: 18-24 FLSB , Certification: With Approval , Unit: Each , Qty.: 1

PART#	GLASS COLOR	DESCRIPTION
929750	Tinted	Sport; Height 150 mm x Width 400 mm
929751	Dark Tinted	Sport; Height 150 mm x Width 400 mm
929752	Clear	Sport; Height 150 mm x Width 400 mm
929753	Black	Sport; Height 150 mm x Width 400 mm
929754	Tinted	Touring; Height 250 mm x Width 400 mm
929755	Dark Tinted	Touring; Height 250 mm x Width 400 mm
929756	Clear	Touring; Height 250 mm x Width 400 mm



Knuckle Rocker Box Covers

- Design inspired by the legendary Harley-Davidson Knucklehead engines
- The EMD Knuckle rockerbox covers install in place of your OEM rockerbox covers and will radically change the look of your engine
- Manufactured in diecast aluminum with CNC-milled gasket surface
- Dimensions and tolerances identical to the OEM part
- OEM Mounting Hardware reusable
- Seal Kit not included (available separately)
- Sold in pairs

Unit: Pair , Qty.: 1

PART#	FITMENT	COLOR	DESCRIPTION
929963	85-94 FX Model, 91-98 Dyna, 84-99 Softail, 85-98 Touring	Raw	For Evo
929964	85-94 FX Model, 91-98 Dyna, 84-99 Softail, 85-98 Touring	Black Cut	For Evo
929965	86-03 Sportster	Raw	For Sportster 86-03
929966	86-03 Sportster	Black Cut	For Sportster 86-03
929967	04-20 Sportster, (except 08-10 XR1200, 10-13 XR1200X)	Raw	For Sportster 04-20
929968	04-20 Sportster, (except 08-10 XR1200, 10-13 XR1200X)	Black Cut	For Sportster 04-20



STX 36 Blackline Twin Shock Absorber with Golden Reservoir

- Single tube
- Piston diameter: 36 mm
- Monotube high pressure gas type of shock absorber with hose mounted external reservoir
- Adjustable rebound damping on single tube shocks. Adjuster wheel above the end eye
- Adjustable compression damping. Adjuster wheel or slot on the reservoir
- Including exposed reservoir mounting brackets

Fitment: 14-24 Touring, (except 14 FLHRSE, 14-21 FLHTKSE, 15-24 FLHXSE, 15-16 FLTRUSE, 18-19, 21-24 FLTRXSE, 18 ANVFLHTKSE, 22 FLTRKSE, 23 FLTRKSEANV, 24 FLTRXSTSE) , **Color:** Blackline, Gold , **Unit:** Pair , **Qty.:** 1

PART#	DESCRIPTION
928123	Length: 310,5 mm, Stroke 78,5 mm, Mounted Spring: 66420-026 (26 N/mm)
928124	Length: 328,5 mm +/- 5 mm, Stroke: 86,5 mm, Mounted Spring: 66420-026 (26 N/mm)

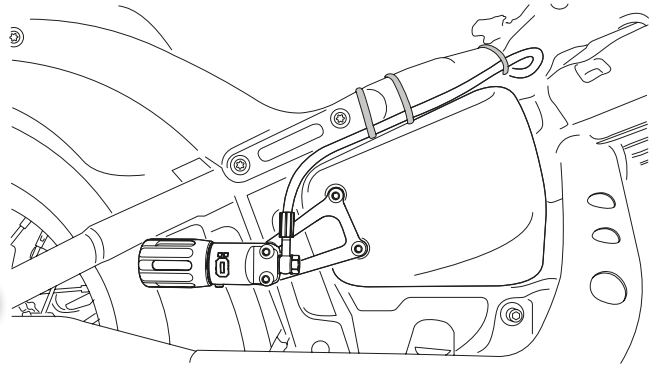

STX 46 Mono Shock without Adjustable Length

The STX 46 shock absorber for the 2018-up Harley-Davidson Softail gives an impressive increase in performance and comfort. Developed to make those long cruises more comfortable but also give the necessary support when hitting the winding roads. This STX 46 has some unique features such as a silver hydraulic preload adjuster, black spring, custom preload handle with laser etched Ö logo and CNC machined aluminum adjuster.

- Type Code Key:
- S: Single tube
- 46: Piston diameter 46mm
- D: Monotube high pressure gas type of shock absorber with internal reservoir in the main body
- R1: Adjustable rebound damping on single tube shocks. Adjuster wheel above the end eye
- S: Hose mounted hydraulic spring preload adjuster

Certification: With Approval , Unit: Each , Qty.: 1

PART#	FITMENT	DESCRIPTION	LENGTH EYE TO EYE
925487	18-19, 23-24 FXBR, 18-20 FXBRS 114, 18 FXBRS 114 ANX, 18-20 FLFB, 18-20 FLFBS 114, 18 FLFBS 114 ANX, 18 FLFBS 114 ANV, 18-24 FLSB, 19-20 FXDRS 114, 21-23 FXLRS, 21-24 FLFBS, 21-22 FXBRS, 23 FLFBS ANV	S46DR1S, Length: 320,5 mm (12,6"), Stroke: 43,5 mm, Spring Rate N/mm: 105 N/mm, Mounted Spring: 21102-36, OE Remote-Position	12,6" (320mm)
925488	18-20 FLDE, 18-20 FXLR, 18-21 FLSL, 18-20 FXBB, 18-21 FLHC, 18 FLHCS 114, 18 FLHCS 114 ANV, 19-20 FLHC 114, 20-24 FXLRS, 20-24 FXST, 21-24 FXBBS, 22-24 FLHCS, 22-24 FXLRST, 23 FLHCSANV	S46DR1S, Length: 320,5 mm (12,6"), Stroke: 43,5 mm, Spring Rate N/mm: 105 N/mm, Mounted Spring: 21102-36, Bracket-Mounted Remote (see image)	12,6" (320mm)
925489	18-20 FXFB, 18, 20 FXFBS 114, 18-19, 23-24 FXBR, 18-20 FXBRS 114, 18-20 FLFB, 18-20 FLFBS 114, 18-24 FLSB, 19 FXFB 114, 19-20 FXDRS 114, 21-24 FXFBS, 21-22 FXBRS, 21-24 FLFBS	S46DR1S, Length 341,5mm (13,4"), Stroke:57,5mm, Spring Rate N/mm: 105N/mm , Mounted Spring: 21103-36, OE Remote-Position	13,4" (340mm)
925490	18-21 FLHC, 18 FLHCS 114, 18 FLHCS 114 ANV, 18-21 FLSL, 18-20 FLDE, 18-20 FXLR, 18-20 FXBB, 19-20 FLHC 114, 20-24 FXLRS, 20-24 FXST, 21-22, 24 FLHCS, 21-24 FXBBS, 22 FXRST, 22-24 FXLRST	S46DR1S, Length 341,5mm (13,4"), Stroke:57,5mm, Spring Rate N/mm: 105N/mm , Mounted Spring: 21103-36, Bracket-Mounted Remote (see image)	13,4" (340mm)

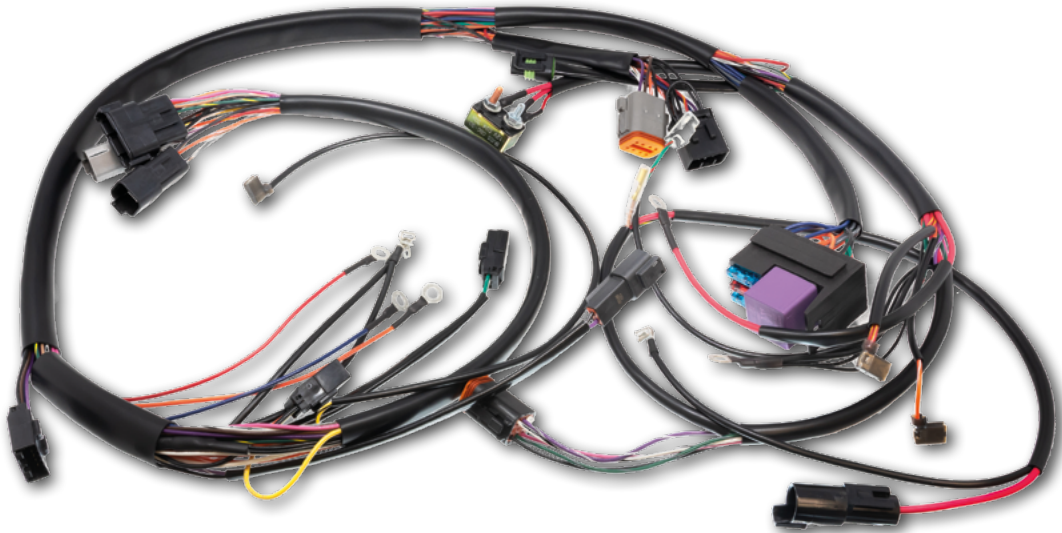

NAME Custom Cycle Products

OE Reproduction Complete Bike Harness

- Replacement Bike Harness
- OEM color-matching harness with ALL OEM connectors pre-installed.
- Fuse block holds a full size, commonly available & replaceable starter relay and (3) ATO fuses.
- A 30-Amp circuit breaker is installed and is ready for any regulator/charging system.
- 100% plug-n-play, easy to install harness that allows for direct connections to all original components.
- This harness is an exact replica of the OEM part number, 70153-99.

Part#: 928119 , Fitment: 99-03 Sportster, (except 99-03 XL1200S) , OEM #: 70153-99 , Unit: Kit , Qty.: 1



NAME Custom Cycle Products

Complete Bike Harness

- OEM color-matching harness with Run/Turn Signal Self Canceling Module.
- Fuse block holds a full size, commonly available & replaceable starter relay and (3) ATO fuses.
- A 30-Amp circuit breaker is installed and is ready for any regulator/charging system.
- Harness provides turn signal functions to the front and rear turn signals.
- Oil, neutral, high beam, and turn signal indicator wiring
- Color matching handlebar switch wiring as found on ,96-13 non-glide models.
- Headlight wiring with headlight socket and terminals.
- Front turn signal connectors and terminals.
- Rear fender harness with connectors and terminals.
- Key switch wiring with ring terminals.
- Coil wire with ring terminals, tachometer, horn, oil sending unit, brake switch and neutral switch wiring with terminals.
- Sections of 3/16", 1/4", 3/8" and 1/2" ID heat shrink included.
- Heavy gauge 12 (+) power and (-) ground wires with terminals for battery connection.

Part#: 928120 , Fitment: 96-05 Dyna, 96-06 Softail , Fitment Note: With basic turn signal function, except EFI models , Description: With Starter Relay, 3-Circuits and Turn Signal Self Canceling Module , Unit: Kit , Qty.: 1



check our dealer store | www.custom-chrome-europe.com



Custom Chrome Europe GmbH | Carl-von-Ossietzky-Straße 8 | 55459 Grolsheim/Germany
 Phone: +49 (0) 6721 - 4 007 - 0 | e-mail: info@customchrome.de | Managing Director: Thomas Noetzel
 Mainz Local Court | Commercial Registry No. 45562 | VAT No. DE811309246



World's Finest Products For Harley-Davidsons



Custombike Luggage Rack

Make your custom bike travel-ready with the removable Thunderbike Custombike luggage rack. Perfect in combination with most Custom rear fenders. This rack is the ideal accessory to add extra storage space for your tours.

- Includes mounting hardware
- Steel and aluminum top-plate
- Black powder-coated
- Capacity: 10 kg (do not use for passenger seats)
- For more space choose optional luggage rack extension plate

Color: Black Powder Coated , Unit: Each , Qty.: 1

PART#	FITMENT	DESCRIPTION
929292	08-17 Softtail, (except 08 FXCW, 08-11 FXCWC, 13-14 FXSBSE, 14-17 FXSB, 16-17 FXSE)	For Late TC Softtail with 200/18 Tire and Customfender
929293	18-24 Softtail, (except 18-19, 23-24 FXBR, 18-20 FXBRS 114, 18 FXBRS 114 ANX, 18-20 FLFB, 18-20 FLFBS 114, 18 FLFBS 114 ANX, 18 FLFBS 114 ANV, 19-20 FXDRS 114, 21-22 FXBRS, 21-22, 24 FLFBS, 23 FLFBSANV)	For M8 Softtail with 200/18 Tire and Customfender
929295	08-17 Softtail, (except 08 FXCW, 08-11 FXCWC, 13-14 FXSBSE, 14-17 FXSB, 16-17 FXSE)	For Late TC Softtail with 260/18 Tire and Customfender
929296	08 FXCW, 08-11 FXCWC, 13-14 FXSBSE, 14-17 FXSB, 16-17 FXSE	For TC Rocker/Breakout with 260/18 Tire and Customfender
929297	18-19, 23-24 FXBR, 18-20 FXBRS 114, 18 FXBRS 114 ANX, 18-20 FLFB, 18-20 FLFBS 114, 18 FLFBS 114 ANX, 18 FLFBS 114 ANV, 19-20 FXDRS 114, 21-22 FXBRS, 21-24 FLFBS, 23 FLFBSANV	For M8 Fat Boy/Breakout/FXDR with 260/18 Tire and Customfender
929291	00-07 Softtail	For Early TC Softtail with 200/18 Tire and Customfender
929294	00-07 Softtail	For Early TC Softtail with 260/18 Tire and Customfender



Custombike Luggage Rack Extension Plate

Extend your Thunderbike Custombike luggage rack. The extension plate allows a secure attachment of larger luggage.

- Size: 200 x 320 mm
- Aluminium

Part#: 929301 , Field of Application: Fits for Thunderbike Custombike luggage racks , Color: Black , Unit: Each , Qty.: 1



Mounting Kit for TB Mid- to Forward Control Conversion Kit for Softail M8

This mounting kit is needed for Thunderbike forward control kit on Softail 18-up models without mid-controls. Floorboard models require additional parts. (2 x Pin, 2 x Spring, 2 x Clip)

Part#: 929338 , Fitment: 18-19, 23-24 FXBR, 18-20 FXBRS 114, 18 FXBRS 114 ANX, 18-20 FLFB, 18-20 FLFBS 114, 18 FLFBS 114 ANX, 18 FLFBS 114 ANV, 18-21 FLHC, 18 FLHCS 114, 18 FLHCS 114 ANV, 19-20 FLHC 114, 19-20 FXDRS 114, 21-22 FXBRS, 21-24 FLFBS, 21-24 FLHCS, 23 FLHCSANV, 23 FLFBSANV , Fitment Note: For Floorboard models additional needed: 2 x pin (HD# 50500702), 2 x spring (HD# 50500703), 2 x clip (HD# 50500701), not included in the kit , Color: Black , Unit: Kit , Qty.: 1



SP-S Toppers Base

- Endcaps for Grips and Forward controls "Base"
- Sold in pairs

Part#: 929323 , Field of Application: For use with Thunderbike Base grips or foot pegs. , Color: Black , Unit: Pair , Qty.: 1



SP-S Grips

These machined aluminum grips Satin can be mounted to match Thunderbike Satin footpeg systems or as a stand-alone gimmick. Matching toppers are included.

- CNC machined by Thunderbike
- Available in pairs

Color: Black Cut, Anodized , Unit: Pair , Qty.: 1

PART#	FITMENT	OPERATION TYPE	BAR Ø
923644	21-24 Sportster S RH1250S, 22-24 Nightster RH975, 23-24 Nightster Special RH975S	Throttle By Wire	7/8"
929325	96-15 Softail, (except 11 FLSTSE2, 12 FLSTSE3, 13-14 FXSBSE, 14-15 FLSTN5E), 96-17 Dyna, (except 16-17 FXDLS), 96-20 Sportster, 96-07 Touring	Throttle Cables	1"
929326	16-24 Softail, 11 FLSTSE2, 12 FLSTSE3, 13-14 FXSBSE, 14-15 FLSTN5E, 08-24 Touring, (except 23-24 FLHXSE, 18-19, 21-24 FLTRXSE, 24 FLHX, 24 FLTRX, 24 FLTRXSTSE), 16-17 FXDLS	Throttle By Wire	1"

NEW PRODUCTS



926543

926544

926545

926548

926547

926548



926549

926550

926551

926552

926553

926554



Clubstyle Riser Kit

- For internal wiring
- CNC machined aluminum
- Including mounting hardware for rigid riser mount
- Choose your riser configuration from various versions:
- For models with digital, round (up- or downwards position possible) or without instrument
- 7" height with 1" pullback or 9" height with 1,5" pullback
- Handlebar clamp diameter: 1 1/4" or 1"

Color: Black Satin , Certification: With Approval , Unit: Kit , Qty.: 1



PART#	FITMENT	FITMENT NOTE	DESCRIPTION	CLAMP Ø
926543	18-19, 23 FXBR, 18-20 FXBRS 114, 18 FXBRS 114 ANX, 18-20 FXBB, 21-22 FXBRS, 21-23 FXBBS, 22-23 FXLRST		Height: 7", For 1 1/4" Handlebar, Digital Instrument	1 1/4"
926544	18-19, 23 FXBR, 18-20 FXBRS 114, 18 FXBRS 114 ANX, 18-20 FXBB, 21-22 FXBRS, 21-23 FXBBS, 22-23 FXLRST		Height: 9", For 1 1/4" Handlebar, Digital Instrument	1 1/4"
926545	18-19, 23 FXBR, 18-20 FXBRS 114, 18 FXBRS 114 ANX, 18-20 FXBB, 21-22 FXBRS, 21-23 FXBBS, 22-23 FXLRST		Height: 7", For 1" Handlebar, Digital Instrument	1"
926546	18-19, 23 FXBR, 18-20 FXBRS 114, 18 FXBRS 114 ANX, 18-20 FXBB, 21-22 FXBRS, 21-23 FXBBS, 22-23 FXLRST		Height: 9", For 1" Handlebar, Digital Instrument	1"
926547	22-23 FXLRS		Height: 7", For 1 1/4" Handlebar, Round Instrument	1 1/4"
926548	22-23 FXLRS		Height: 9", For 1 1/4" Handlebar, Round Instrument	1 1/4"
926549	22-23 FXLRS		Height: 7", For 1" Handlebar, Round Instrument	1"
926550	22-23 FXLRS		Height: 9", For 1" Handlebar, Round Instrument	1"
926551	84-23 Softail, 91-17 Dyna, 86-20 Sportster	Fits only models with 3.5" center-to-center riser spacing	Height: 7", For 1 1/4" Handlebar, No Instrument	1 1/4"
926552	84-23 Softail, 91-17 Dyna, 86-20 Sportster	Fits only models with 3.5" center-to-center riser spacing	Height: 9", For 1 1/4" Handlebar, No Instrument	1 1/4"
926553	84-23 Softail, 91-17 Dyna, 86-20 Sportster	Fits only models with 3.5" center-to-center riser spacing	Height: 7", For 1" Handlebar, No Instrument	1"
926554	84-23 Softail, 91-17 Dyna, 86-20 Sportster	Fits only models with 3.5" center-to-center riser spacing	Height: 9", For 1" Handlebar, No Instrument	1"



2" Straight Riser

- For 1 1/4" handlebar diameter
- Height: 2"
- Without pullback
- Bolt nuts included
- Sold in pairs

Fitment: 18-19, 23-24 FXBR, 18-20 FXBRS 114, 18 FXBRS 114 ANX, 18-20 FXFB, 18, 20 FXFBS 114, 18-24 FLSB, 19 FXFB 114, 21-22 FXBRS, 21-24 FXFBS , **Field of Application:** For all models equipped with 1 1/4" handlebars , **Color:** Black , **Certification:** With Approval , **Clamp ø:** 1 1/4" , **Unit:** Pair , **Qty.:** 1

PART#	DESCRIPTION
929336	Drilled, For Internal Wiring, 1 1/4" Clamp Diameter
929337	Non-Drilled, 1 1/4" Clamp Diameter



Digital Speedometer Housing

The housing is suitable for combination with Thunderbike Digital Speedometer brackets for handlebar or below the upper triple clamp.

- Fits H-D original digital speedo of FXBB and FXBR/s models
- Order bracket and speedometer separately

Part#: 929327 , **Fitment:** 18-19, 23-24 FXBR, 18-20 FXBRS 114, 18 FXBRS 114 ANX, 18-20 FXBB, 21-24 FXBBS, 21-22 FXBRS , **Color:** Black , **Unit:** Each , **Qty.:** 1



Digital Speedometer Housing Bracket

For mounting the Thunderbike Digital Speedometer Housing for OE Digital Speedometers or identical speedometer. Speedometer and Speedometer Housing not included.

Fitment Note: Speedometer of FXST or FXBR/S needed , **Color:** Black , **Unit:** Each , **Qty.:** 1

PART#	FITMENT	DESCRIPTION
929328	18-24 Softail	For Fastening Between Risers to Upper Triple
929329	18-19, 23-24 FXBR, 18-20 FXBRS 114, 18 FXBRS 114 ANX, 18-20 FXFB, 18, 20 FXFBS 114, 18-24 FLSB, 19 FXFB 114, 21-22 FXBRS, 21-24 FXFBS	For Clamping to 1 1/4" Handlebar Between Risers

NEW PRODUCTS



929310



929310



929310



929312



929312



929312



653076



Upper Fork End Caps

- Sold in pairs

Unit: Pair , Qty.: 1

PART#	FITMENT	FITMENT NOTE	COLOR
929310	84-17 Softail, (except 88-95, 97-03 FXSTS, 95-97 FXSTSB, 96 FLSTF, 97-03 FLSTS, 01-03 FLSTSI, 01-02, 04-06 FXSTSI, 05-06 FLSTSCI, 07 FLSTSC, 07 FXSTSSE, 08-11 FLSTSB, 08 FXCW, 08-11 FXCWC, 08 FXSTSSE2, 09 FXSTSSE3, 13-14 FXSBSE, 14-17 FXSB, 15 FLSTNSE, 16-17 FXSE), 93-03 FXDWG, 02 FXDWGSE3, 04-05 FXDWGI	With telescopic forks and plug with wrench width of 1 3/8", does not fit inverted forks	Black
929311	84-17 Softail, (except 88-95, 97-03 FXSTS, 95-97 FXSTSB, 96 FLSTF, 97-03 FLSTS, 01-03 FLSTSI, 01-02, 04-06 FXSTSI, 05-06 FLSTSCI, 07 FLSTSC, 07 FXSTSSE, 08-11 FLSTSB, 08 FXCW, 08-11 FXCWC, 08 FXSTSSE2, 09 FXSTSSE3, 13-14 FXSBSE, 14-17 FXSB, 15 FLSTNSE, 16-17 FXSE), 93-03 FXDWG, 02 FXDWGSE3, 04-05 FXDWGI	With telescopic forks and plug with wrench width of 1 3/8", does not fit inverted forks	Flat Black
929312	18-19, 23-24 FXBR, 18-20 FXBRS 114, 18 FXBRS 114 ANX, 21-22 FXBRS		Black
653075	06-17 Dyna	Fits only 49mm fork tubes	Aluminium Polished
653076	06-17 Dyna	Fits only 49mm fork tubes	Bi-Color



Lower Fork Cover

- Made from aluminium
- Sold in pairs

Color: Gloss Black , Unit: Pair , Qty.: 1

PART#	FITMENT
929330	13-14 FXSBSE, 14-17 FXSB
929331	18-19, 23-24 FXBR, 18-20 FXBRS 114, 18 FXBRS 114 ANX, 21-22 FXBRS
929332	18-20 FXBB, 20-24 FXST, 21-24 FXBBS



918386



918387



918094



Inside Plate Stripe LED Turn Signal/Taillight/ Brake Light

- 3-in-1 turn signal, tail light and brake light
- Modern LED technology for brightness and durability
- E-mark for road approval
- Supplied in pairs
- Mounting material included
- Available with 0° slope or 20° slope for better visibility
- Tech Tip:
- Thunderbike Inside Plates are prefabricated to fit these turn signals, which makes installation even easier.

Field of Application: For Thunderbike inside license plate or other aftermarket license plate base plates, mounting may require load equalizer , Certification: E-Approved , Unit: Pair

PART#	COLOR	DESCRIPTION
918386	Polished	0° Slope
918387	Black Satin	0° Slope
918094	Gloss Black	0° Slope
929320	Polished	20° Slope
929321	Gloss Black	20° Slope
929322	Black Satin	20° Slope

NEW PRODUCTS



Medium Pro Side Mount License Plate Bracket

The Thunderbike Medium Pro side mount bracket is the logical further development of the popular Medium and Long Thunderbike side mount licence plate brackets. The lateral bracket ensures an absolutely clean rear end, as the standard central number plate moves to the left-hand side and the view of the rear tyre is unobstructed. The medium length allows the licence plate to be fitted in accordance with regulations, so that the licence plate fits perfectly into the silhouette of the bike. The original mounting construction of the rear axle is retained, which also guarantees the final strength of the rear axle.

- Powder coated stainless steel
- Unrestricted use of axle covers possible
- Robust construction ensures less vibration of the licence plate
- Variable positioning of the licence plate possible
- Including mounting hardware
- License plate base plate and lighting accessories sold separately

Certification: With Approval , Unit: Each , Qty.: 1

PART#	FITMENT	COLOR
926517	18-23 Softail, (except 18-20 FXFB, 18, 20 FXFBS 114, 19 FXFB 114, 19-20 FXDRS 114, 21-23 FXFBS)	Black
926518	18-23 Softail, (except 18-20 FXFB, 18, 20 FXFBS 114, 19 FXFB 114, 19-20 FXDRS 114, 21-23 FXFBS)	Black Satin
926519	00-07 Softail	Black
926520	08-17 Softail	Black
926521	08-17 Softail	Black Satin
926522	06-07 Dyna	Black
926523	08-17 Dyna	Black
926524	18-20 FXFB, 18, 20 FXFBS 114, 19 FXFB 114, 21-23 FXFBS	Black Satin
926525	19-20 FXDRS 114	Black Satin
926527	00-03 Sportster	Black
926528	04-20 Sportster	Black
926530	02-17 V-Rod	Black



926531



926531



926532



Aluminium Medium Length Side Mount License Plate Bracket with Approval

- Including mounting hardware
- License plate base plate and lighting accessories sold separately

Certification: With Approval , Unit: Each , Qty.: 1

PART#	FITMENT	COLOR
926531	18-23 Softail, (except 18-20 FXFB, 18, 20 FXFBS 114, 19 FXFB 114, 19-20 FXDRS 114, 21-23 FXFBS)	Black, Anodized
926532	19-20 FXDRS 114	Black Satin, Anodized



929319



918093



License Plate Bracket

- Replaces the OEM bracket
- Fits best in combination with Thunderbike Inside Plate
- Note: Requires license plate lighting (not included)

Unit: Each , Qty.: 1

PART#	FITMENT	COLOR	DESCRIPTION
918093	18-24 FL5B	Black	For Softail Sport Glide
929319	18-20 FXFB, 18, 20 FXFBS 114, 19 FXFB 114, 21-24 FXFBS	Flat Black	For Softail Fat Bob



Helix Mid-Mount License Plate Base Plate Adapter

This mid mount adapter is mounted instead of fender mounted OE taillight and adopts the license plate base plate.

- Milled from billet aluminium
- With cable guide
- Various mounting heights thanks to multiple screw-on points

Part#: 929318 , Fitment: 23-24 FLHXSE, 23-24 FLTRXSE, 24 FLTRK, 24 FLHX, 24 FLTRX, 24 FLTRXSTSE , Color: Black , Unit: Kit , Qty.: 1



TB-S Air Cleaner

The Thunderbike TB-S Custom air filter with laser engraved lettering provides with its noble design for a perfect look on the bike.

- With high quality and durable K&N filter insert
- Includes model-specific mounting kit
- 3D machined from billet aluminium
- Flat black with TB-S lettering
- Approved in combination with original H-D, as well as Jekill & Hyde exhaust systems
- The power filter comes including a, for maintenance removable reducing screen, which closes the outer holes in the cover and brings the air flow to series level.
- Made in Germany

Color: Flat Black , Certification: With Approval , Unit: Kit , Qty.: 1

PART#	FITMENT	OPERATION TYPE
929340	17-20 Sportster	Throttle Cables
929341	99-15 Softail, (except 11 FLSTSE2, 12 FLSTSE3, 13-14 FXSBSE, 14-15 FLSTNSE), 99-17 Dyna, (except 16-17 FXDLS), 99-07 Touring, (except 99-01 FLHRCI, 99-01 FLHTCUI, 99-01 FLTRI)	Throttle Cables
929342	07-16 Sportster, (except 08-10 XR1200, 10-13 XR1200X)	Throttle Cables
929343	18-24 Softail, 17-24 Touring, (except 23-24 FLHXSE, 23-24 FLTRXSE, 24 FLTRXSTSE)	Throttle By Wire



New Custom Air Cleaner

- Billet Aluminium
- Thunderbike New Custom Logo
- K&N Filter Element included (cleanable & longlife)
- Includes mounting kit
- CNC machined Aluminium
- Approved with OE exhaust and in combination with Jekill & Hyde exhaust

Color: Black , Certification: With Approval , Unit: Kit , Qty.: 1

PART#	FITMENT	OPERATION TYPE
929344	17-20 Sportster	Throttle Cables
929345	99-15 Softail, (except 11 FLSTSE2, 12 FLSTSE3, 13-14 FXSBSE, 14-15 FLSTNSE), 99-17 Dyna, (except 16-17 FXDLS), 99-07 Touring, (except 99-01 FLHRCI, 99-01 FLHTCUI, 99-01 FLTRI)	Throttle Cables
929346	07-16 Sportster, (except 08-10 XR1200, 10-13 XR1200X)	Throttle Cables
929347	16-17 Softail, 11 FLSTSE2, 12 FLSTSE3, 13-14 FXSBSE, 14-15 FLSTNSE, 08-16 Touring, 16-17 FXDLS	Throttle By Wire



DRILLED OVAL



GRAND CLASSIC



TORQUE



TORQUE WITH THUNDERBIKE LOGO



GRAND PRIX



TB-S



Oval Airbox Air Cleaner Cover

Thunderbike Airbox Cover can be used in combination with OEM Aircleaner of 114 cui Milwaukee-Eight models or Thunderbike Oval Airbox Air Cleaner for 107cui Engines.

- CNC machined aluminum

Fitment: 18-20 FXBRS 114, 18 FXBRS 114 ANX, 18-20 FLFBS 114, 18 FLFBS 114 ANX, 18 FLFBS 114 ANV, 18 FLHCS 114, 18 FLHCS 114 ANV, 18, 20 FXFBS 114, 19-20 FLHC 114, 19-20 FXDRS 114, 19 FXFB 114, 21-24 FXBBS, 21-22 FXBRS, 21-24 FLFBS, 21-24 FLHCS, 21-24 FXFBS, 23 FLHCSANV, 23 FLFBSANV, 17-19 FLHXSE, 17-21 FLHTKSE, 18 FLTRXSE, 18 ANVFLHTKSE, 21, 23 FLHXS, 21-24 FLHRXS, 21-23 FLTRXS, 21 FLH, 22 FLHX, 22 FLTRKSE, 20-22 FLHTCUTGSE , Field of Application: For use with Thunderbike Oval Airbox air cleaner kits. , Color: Bi-Color, Anodized , Unit: Each , Qty.: 1

PART#	DESCRIPTION
913141	Drilled Oval
913142	Grand Classic
913143	Torque
913144	Torque with Thunderbike Logo
913145	Grand Prix
929339	TB-S



929348



929350



TB-S Timer Cover

- Milled aluminium
- Sold each

Color: Black Cut, Anodized , Unit: Each , Qty.: 1

PART#	FITMENT
929348	18-24 Softtail, 17-24 Touring, (except 23-24 FLHXSE, 23-24 FLTRXSE, 24 FLTRXSTSE, 24 FLHX, 24 FLTRX), 17-24 Trike
929350	00-17 Softtail, 99-17 Dyna, 99-16 Touring, 09-16 Trike



SP-S Radiator Shroud Set

- Set includes panels for both sides of the water cooler
- Emphasizes the striking lines of your Sportster or Nightster
- Adds a sporty look and extra dimension to your bike
- Made from high quality aluminum
- Easy installation and precise fit
- Durable and weather-resistant
- Including mounting screws

Part#: 929309 , **Fitment:** 21-24 Sportster S RH1250S, 22-24 Nightster RH975, 23-24 Nightster Special RH975S , **Color:** Bi-Color , **Unit:** Set , **Qty.:** 1



TB-S Clutch Cover

- Milled aluminium
- Sold each

Color: Black Cut, Anodized , **Unit:** Each , **Qty.:** 1

PART#	FITMENT
929349	19-24 Softtail, 18 FLSB
929351	00-18 Softtail, (except 18 FLSB), 99-17 Dyna, 99-16 Touring, (except 15-16 FLHTKL, 15-16 FLHTCUL)



Open Mind Clutch Cover

- CNC machined aluminium with black anodized finish
- Bicolor design
- Sold each

Color: Bi-Color, Anodized , **Unit:** Each , **Qty.:** 1

PART#	FITMENT	DESCRIPTION
652996	04-20 Sportster	6-Hole
929315	19-24 Softtail, 18 FLSB	5-Hole



Belt Guard for M8 Softails

- Provides a visually perfect look
- Made from aluminium
- Simple installation
- Direct OEM replacement

Part#: 929316 , **Fitment:** 18-24 Softtail, (except 19-20 FXDRS 114) , **Color:** Black Powder Coated , **Unit:** Each , **Qty.:** 1





Belt Guard Bracket for Custom Swing Arms

This mounting kit allows the Thunderbike belt guard to be fitted to swingarms where the bracket no longer fits. The 2-piece clamp is precisely milled from aluminum to follow the contour of the swingarm tube exactly. This ensures a secure and tight fit of the belt guard.

- Made from aluminum
- Belt guard not included

Part#: 929317 , Fitment: 18-24 Softail, (except 19-20 FXDRS 114) , Fitment Note: For custom swingarms without OEM bracket , Color: Black , Unit: Kit , Qty.: 1



Front Pulley Cover for Sportster S and Nightster

The Thunderbike design cover for the front belt pulley provides a classy black cut look.

- Machined aluminium
- Short belt guard is included
- Pulley-cover rotates with

Fitment: 21-24 Sportster S RH1250S, 22-24 Nightster RH975, 23-24 Nightster Special RH975S , Color: Black Cut , Qty.: 1

PART#	DESCRIPTION	UNIT
923639	Plain Design	Kit
929308	SP-S Design	Each



TB-S LOGO



THUNDERBIKE LOGO



Brake Caliper Inserts

- CNC milled cover for the standard brake caliper
- Black with Thunderbike or TB-S Logo laser engraving
- Sold each

Color: Black, Anodized , Unit: Each , Qty.: 1

PART#	FITMENT	FITMENT NOTE	DESCRIPTION
929302	00-24 Softail, (except 00-03 FLSTS, 00-03 FXSTS, 01-03 FLSTSI, 01-02, 04-06 FXSTSI, 05-06 FLSTSCI, 07 FLSTSC, 07 FXSTSSE, 08-11 FLSTSB, 08 FXSTSSE2, 09 FXSTSSE3), 00-17 Dyna, 00-03 Sportster, 00-07 Touring, 02-05 V-Rod	18-up Softail and Sportster 14-up only for front caliper	Thunderbike Logo
929303	18-24 Softail		Thunderbike Logo
929304	14-20 Sportster		Thunderbike Logo
929305	00-24 Softail, (except 00-03 FLSTS, 00-03 FXSTS, 01-03 FLSTSI, 01-02, 04-06 FXSTSI, 05-06 FLSTSCI, 07 FLSTSC, 07 FXSTSSE, 08-11 FLSTSB, 08 FXSTSSE2, 09 FXSTSSE3), 00-17 Dyna, 00-03 Sportster, 00-07 Touring, 02-05 V-Rod	18-up Softail and Sportster 14-up only for front caliper	TB-S Logo
929306	18-24 Softail		TB-S Logo
929307	14-20 Sportster		TB-S Logo

NEW PRODUCTS



917138

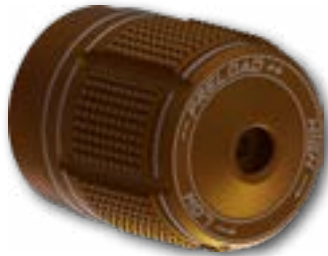

917139



929333



Shock Adjusting Knob

- Replaces OEM part

Unit: Each , Qty.: 1



PART#	FITMENT	COLOR
917138	18-22 Softail, (except 18-21 FLHC, 18 FLHCS 114, 18-20 FLDE, 18-20 FXLR, 18-20 FXBB, 19-20 FLHC 114, 20-22 FXLRS, 20-22 FXST, 21-22 FXBBS, 22 FXLRST, 22 FLHCS)	Black Satin, Anodized
917139	18-22 Softail, (except 18-21 FLHC, 18 FLHCS 114, 18-20 FLDE, 18-20 FXLR, 18-20 FXBB, 19-20 FLHC 114, 20-22 FXLRS, 20-22 FXST, 21-22 FXBBS, 22 FXLRST, 22 FLHCS)	Orange
929333	21-24 Sportster S RH1250S	Black Satin, Anodized



Custom Alu Gas Tank

- Capacity: 15 liters
- Recessed tank cap (included)
- Stretched dragstyle design
- Pressure tested
- Accepts OE injection pressure pump (modifications necessary)
- Unpainted aluminium
- Mounting hardware included
- Made in Hamminkeln, Germany



Part#: 929352 , Fitment: 18-24 Softail , Color: Raw , Certification: With Approval , Unit: Each , Qty.: 1

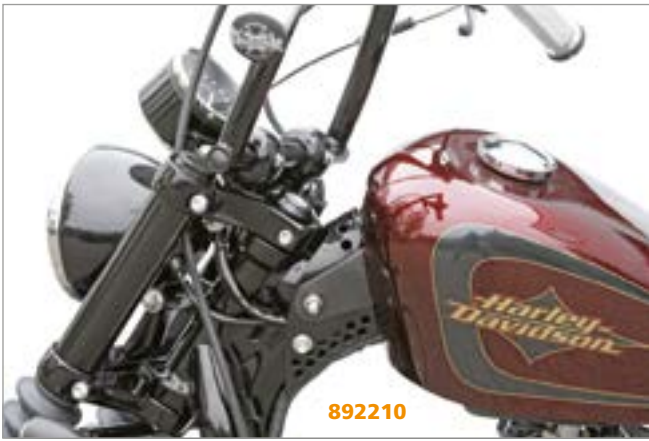

Tank Pin-Up Kit

- Black powdercoated
- Tank lift kit
- Ideal for a cool chopper look
- Easy mounting

Color: Black Powder Coated , Qty.: 1

PART#	FITMENT	UNIT
892210	12-16 XL1200V, 10-20 XL1200X, 19-20 XL1200XS	Each
929335	18-19, 23-24 FXBR, 18-20 FXBRS 114, 18 FXBRS 114 ANX, 18-20 FXBB, 20-24 FXST, 21-24 FXBBS, 21-22 FXBRS	Kit



Rear Tank Mount Stud

- Replaces OEM tank mount
- By removing the large oem nut, seats fit closer to the tank

Part#: 929334 , Fitment: 18-24 Softail , Color: Black , Unit: Each , Qty.: 1



SP-S Windshield Kit

- Creates a sporty look
- Bracket Bi-Color
- Including windshield and mounting hardware

Part#: 929324 , Fitment: 21-24 Sportster S RH1250S , Color: Black Cut , Certification: With Approval , Unit: Kit , Qty.: 1



PLAIN DESIGN



SP-S DESIGN



Heat Exchanger Cover

This Thunderbike cover hides the unsightly right side of the heat exchanger.

- Made from Aluminium
- Easy installation
- Sold each

Fitment: 21-24 Sportster S RH1250S, 22-24 Nightster RH975, 23-24 Nightster Special RH975S , Unit: Each , Qty.: 1

PART#	COLOR	DESCRIPTION
929313	Textured Black	Plain Design, Easy Installation (Adhesive Back)
929314	Black Powder Coated	SP-S Design, Ribbed, Including Mounting Parts



check our dealer store | www.custom-chrome-europe.com





World's Finest Products For Harley-Davidsons

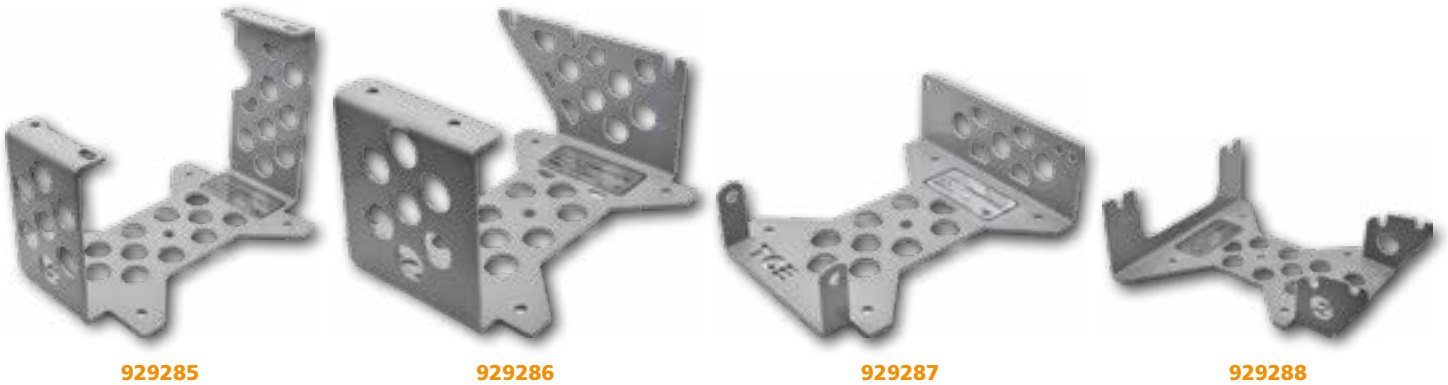

Engine Stand

This sturdy engine stand is ideal for performing repairs, tuning modifications or other jobs on removed engines. May be bolted to a work bench for added stability.

Color: Gray Powder Coated , Material: Steel , Unit: Each , Qty.: 1

PART#	FITMENT	DESCRIPTION
929285	70-84 FL Shovel, 71-84 FX Shovel, 85-94 FX Model, 91-98 Dyna, 84-99 Softtail, 85-98 Touring	For Big Twin 70-99
929286	99-17 Dyna, 99-16 Touring, 09-16 Trike	For Twin Cam A
929287	00-17 Softtail	For Twin Cam B
929288	18-24 Softtail, 17-24 Touring, 17-24 Trike	For Milwaukee Eight



Transmission Stand

This sturdy transmission stand is ideal for performing repairs, transmission revisions or other jobs on removed transmissions. May be bolted to a work bench for added stability.

Part#: 929289 , Fitment: 91-05 Dyna, 84-06 Softtail, 85-06 Touring, 85-94 FX Model, 71-84 FX Shovel, 66-84 FL Shovel, 65 Panhead , Fitment Note: Not for 65-E79 3-speed models , Color: Gray Powder Coated , Description: For 4-and 5-Speed , Material: Steel , Unit: Each , Qty.: 1

[check our dealer store | www.custom-chrome-europe.com](http://www.custom-chrome-europe.com)





World's Finest Products For Harley-Davidsons



Fanny Pack

Grey Camo Fanny Pack with Silicone WCC Logo Badge. The Pack has several compartments to stuff your Stacks. Made out of 600D Nylon. The West Coast Choppers Text is embossed in the Waist Strap. The Waist Strap is adjustable to fit all.

- 100% Polyester

Part#: **929793** , Color: **Black**



Travel Backpack

Black Travel Backpack made out of high quality 840D Nylon. The bag has various compartments, 2 on the side and 2 main compartments. Within the main compartments there are extra compartments for your laptop and to manage your stuff while on the road. The whole inside the back is lined to keep it waterproof. On the upper of the bag there is an opening for wires of your devices. The Shoulder Straps are adjustable and have clips to adapt it to your body. All zippers have little Logo Straps and the Main Logo is in 3D.

- 100% Nylon (840 Dernier)

Part#: **929794** , Color: **Black**



Cross Body Travel Pack

Cross Pack in perfect to take your stuff with you while on the road. The bag has a silicon WCC Logo batch on the front and the Straps are heat embossed with West Coast Choppers. The Pack has three outer compartments where the biggest has a fourth hidden compartment with Zipper.

- 100% Polyester

BLACK | **CAMO**

929795 | **929796**



Lined Cargo Workjacket

This Classic Twill Cotton Cargo Jacket is a timeless Blue Collar Piece with a nice and comfortable cut and feel. The Jacket has Snap Buttons with embossed OG Logos, inside Lining for your comfort, inside Pocket, 2 front Pockets, small WCC woven Label, adjustable Snaps at Cuffs.

- Shell: 100% Cotton; Lining 100% Nylon

SIZE	BLACK	KHAKI
S	929918	929925
M	929917	929924
L	929916	929923
XL	929919	929926
2XL	929913	929920
3XL	929914	929921
4XL	929915	929922

OG Lined Workjacket

Based on an American Classic this lined black Workjacket is made of a Polyester/Cotton outer Shell and a Nylon Taffeta inner lining. At the front left Chest the OG Cross Logo is embroidered, at the back the OG Cross Logo is embroidered in big size. At the lower Front a OG Logo woven Label is stitched on. The Jacket come in a Classic Loose Fit and is perfect for chilly Days and can be used as an all day Essential.

- Shell: 65% Polyester, 35% Cotton. Lining And Padding: 100% Polyester

Color: Black

SIZE	BLACK
S	929802
M	929801
L	929800
XL	929803
2XL	929797
3XL	929798
4XL	929799



Sherpa Lined Canvas Jacket Duck

Based on an american Original we go to our Medium lined sherpa Jackets. Nice and comfortable fit with Snap Button closure. The Sleeves are Nylon lined for your comfort, the Body is fully sherpa lined. The Jackets come in a comfort cut.

- Shell: 100% Cotton; Lining 100% Polyester

Color: Brown

SIZE	BROWN
S	929830
M	929829
L	929828
XL	929831
2XL	929825
3XL	929826
4XL	929827



Sherpa Lined Flannel Jacket

Classic Work Flannel with Snap buttons and a Sherpa Lining to make it an all year favourite. The Sleeves are Polyester lined, not sherpa for your comfort. The Body is fully sherpa lined. On the left Chest above the Pocket West Coast Choppers is embroidered as well as the OG Cross Logo on the left Sleeve. At the bottom front a woven WCC Label is stitches on. The Flannels come in a comfort cut, the Hood is made of double self fabric in 80% Cotton/20% Polyester.

- Shell: 100% Cotton; Lining And Padding: 100% Polyester

SIZE	BLACKGRAY	BROWNOANGE	NAVYRED
S	929823	929816	929809
M	929822	929815	929808
L	929821	929814	929807
XL	929824	929817	929810
2XL	929818	929811	929804
3XL	929819	929812	929805
4XL	929820	929813	929806



Wool Lined Plaid Jacket

Red/Black High Quality Woolen Shirt Jacket. The outer Shell is made of Wool and the lining is made of Polyester. The OG branded Snap Buttons make this an all day favourite.

- Shell Fabric 100% Wool; Lining 100% Nylon

Color: Black, Red

SIZE	BLACKRED
S	929858
M	929857
L	929856
XL	929859
2XL	929853
3XL	929854
4XL	929855



Everyday Heavy Duty Work Vest made of Heavy Canvas Outershell and Polyester Lining and Insulation to keep you warm. This american classic is a daily user. They come in a comfort work cut.

- Inside Pocket
- Lined and Insulated
- Heavy Duty Canvas in black
- Big front Pockets with Rivets
- Brass Heavy Duty Zipper
- Shell: 65% Polyester, 35% Cotton. Lining And Padding: 100% Polyester



Sherpa Lined Denim Jacket

Based on an american Original we go to our Medium lined sherpa Jackets. Nice and comfortable fit with Snap Button closure. The Sleeves are Nylon lined for your comfort, the Body is fully Sherpa lined. The Jackets come in a comfort cut.

- Shell: 100% Cotton; Lining 100% Polyester

Color: Denim Blue

SIZE	DENIM BLUE
S	929833
M	929834
L	929835
XL	929832
2XL	929838
3XL	929837
4XL	929836

SIZE	BLACK
S	929851
M	929850
L	929849
XL	929852
2XL	929846
3XL	929847
4XL	929848



Heavy Duty Canvas Work Jacket

This lined Canvas Jacket is made to last. The Design and Fabrication ensure a lightweight yet strong Fabrication for your comfort, keeping you warm when the temperature drops. Because of the lining, Front Pockets are re-inforced with Rivets. Made in a comfort cut to move freely when wearing.

- Shell: 100% Cotton; Lining 100% Polyester

Color: Black

SIZE	BLACK
S	929844
M	929843
L	929842
XL	929845
2XL	929839
3XL	929840
4XL	929841



Wool Lined Plaid Jacket

High Quality Woolen Shirt Jacket. The outer Shell is made of Wool and the lining is made of Polyester. The OG branded Snap Buttons make this an all day favourite.

- Shell Fabric 100% Wool; Lining 100% Nylon

SIZE	BLACK	BLACKGRAY
S	929872	929865
M	929871	929864
L	929870	929863
XL	929873	929866
2XL	929867	929860
3XL	929868	929861
4XL	929869	929862



OG Cross Long Sleeve

White Long Sleeve made from the finest Cotton available for a nice touch and feel, featuring our OG Cross ATX in black.

- 100% Cotton

SIZE	BLACK	WHITE
S	929884	929878
M	929883	929877
L	929882	929876
XL	929885	929879
2XL	929880	929874
3XL	929881	929875



OG Classic T-Shirt

Whatever, you can never go wrong with something it all started with! Solid White Shirt made from the finest Cotton available for a nice touch and feel, featuring our OG Cross lbc.

- 100% Cotton

SIZE	BLACK	WHITE
S	929899	929892
M	929898	929891
L	929897	929890
XL	929900	929893
2XL	929894	929888
3XL	929895	929889
4XL	929896	



Riser Shirt

This everyday favourite Flannel is made of High Quality 65/35 Cotton/Polyester Twill Fabric with a weight of 9.2oz/260grams. The Shirts have a comfort cut, with a right Chest Flap Pocket, and a open left Chest Pocket. The left Chest Pockets features our WCC OG Cross Logo and on the Plaquet we have a West Coast Choppers manufacturing Label.

- 65% Polyester, 35% Cotton

SIZE	BLUEBROWN	GRAYWHITE
S	929911	929905
M	929910	929904
L	929909	929903
XL	929912	929906
2XL	929907	929901
3XL	929908	929902



OG Classic Beanie

Woven 100% Acryl Beanie with our OG Cross Logo embroidered at the front and Jesse's Signature embroidered at the side.

- 100% Acryl

SIZE	BLACK	GRAY
One Size fits all	929886	929887



 check our dealer store | www.custom-chrome-europe.com



Custom Chrome Europe GmbH | Carl-von-Ossietzky-Straße 8 | 55459 Grolsheim/Germany
 Phone:+49 (0) 6721 - 4 007 - 0 | e-mail: info@customchrome.de | Managing Director: Thomas Noetzel
 Mainz Local Court | Commercial Registry No. 45562 | VAT No. DE811309246



World's Finest Products For Harley-Davidsons



World's Finest Products For Harley-Davidsons

Motorcycle Parts Since 1970 Backpack

- One main and 2 smaller compartments
- Two side pockets for small water bottles

Part#: **925237** , Color: **Black, Orange**



Night Leg Bag

The cool-looking compact Night leg bag from Jack's Inn 54 has a large main zippered overlap pocket, a second zippered pocket and a secret inner pocket with a zipper. The adjustable waist strap and adjustable leg straps guarantee a comfortable fit.

- Full Cowhide Leg Bag Night
- 2 large zipper compartments with flap on the front
- Adjustable leg strap
- Adjustable belly belt
- 1 large zipper compartment on the back
- Dimensions: 30 x 20 x 4 cm
- High quality metal parts
- Note: Leather is tanned animal skin - a natural product. Irregular grain and possible abrasion of the color are not defects of the product, but a guarantee for the authenticity of the finely polished leather and the vegetable tanning. Traces of use, such as scratches, are also part of the intended look of brand-new bags and do not constitute a defect. It is typical for this leather to show signs of wear after a short time. It is recommended that you do not use any care products at the beginning, as this is a desired effect. Sufficient protection is provided as the leather is oiled and/or waxed.



PART# | **COLOR**

929766 | Black

929767 | Brown

929768 | Oilpulled Black



Twilight Leg Bag

The small Jack's Inn 54 Twilight leg bag is perfect for bikers. Made from high-quality leather, it offers enough space for important items. The hip and thigh strap ensures a secure hold while riding. The vintage colour gives the bag a special look and makes it an eye-catcher. A must-have for anyone looking for a practical and stylish leg bag.

- Leg bag Twilight made from full-grain cowhide leather
- 1 large zip pocket with card slots, mobile phone pocket and zip pocket inside
- 1 small front zip pocket
- Adjustable and removable leg strap with lobster clasp, max. length 60 cm
- Adjustable waist strap with lobster clasp, max. length 105 cm
- Dimensions: 22 x 17 x 7 cm
- High quality metal parts
- Note: Leather is tanned animal skin - a natural product. Irregular grain and possible abrasion of the color are not defects of the product, but a guarantee for the authenticity of the finely polished leather and the vegetable tanning. Traces of use, such as scratches, are also part of the intended look of brand-new bags and do not constitute a defect. It is typical for this leather to show signs of wear after a short time. It is recommended that you do not use any care products at the beginning, as this is a desired effect. Sufficient protection is provided as the leather is oiled and/or waxed.

PART#	COLOR
929769	Black
929770	Brown
929771	Oilpulled Black



Sandstorm Leg Bag

Original Jack's Inn 54 leg bag made of sturdy canvas and roughened full-grain cowhide.

- High quality material mix of leather and canvas in rocking rough vintage style
- Dynamic shape
- Logo embossing on the back
- Sturdy Jack's Inn 54 lining
- Jack's Inn 54 leather patch on the front
- 2 large pockets with flap on the front
- Adjustable leather and „washed canvas“ leg strap up to max. 84 cm
- Adjustable leather and washed canvas waist strap up to max. 106 cm
- 1 large zipped compartment on the back
- Dimensions: 20 x 24 x 4 cm
- Note: Leather is tanned animal skin - a natural product. Irregular grain and possible abrasion of the color are not defects of the product, but a guarantee for the authenticity of the finely polished leather and the vegetable tanning. Traces of use, such as scratches, are also part of the intended look of brand-new bags and do not constitute a defect. It is typical for this leather to show signs of wear after a short time. It is recommended that you do not use any care products at the beginning, as this is a desired effect. Sufficient protection is provided as the leather is oiled and/or waxed.

PART#	COLOR
929772	Black
929773	Gray

NEW PRODUCTS



Revenge Bodybag

The Revenge Body Bag will be your faithful companion for all things fun: At festivals, on vacation, shopping or going for a walk. So you have your hands free for the really important things in life. The special feature of the bag is that the strap can be fastened at the bottom using the carabiner on the side of your choice. Thanks to the different carrying options, you can always carry your small valuables comfortably and, above all, close to your body!

- Body bag Revenge made of full-grain cowhide with Bad Ass logo
- With extendable shoulder strap up to 110 cm
- Shoulder strap with carabiner, different carrying options
- 1 small zipped compartment on the front
- 1 large inside pocket with zipper and small one with Velcro fastener
- Inside pocket: zipped compartment, small carabiner, cell phone pocket, Jack's Inn 54 logo
- 1 small zipped compartment at the back / on the back
- Jack's Inn 54 logo embossed on the back
- Outer dimensions: 36 x 19 x 5 cm
- Inside dimensions: 22 x 15 x 4 cm
- Note: Leather is tanned animal skin - a natural product. Irregular grain and possible abrasion of the color are not defects of the product, but a guarantee for the authenticity of the finely polished leather and the vegetable tanning. Traces of use, such as scratches, are also part of the intended look of brand-new bags and do not constitute a defect. It is typical for this leather to show signs of wear after a short time. It is recommended that you do not use any care products at the beginning, as this is a desired effect. Sufficient protection is provided as the leather is oiled and/or waxed.

PART#	COLOR
929780	Black
929781	Brown
929782	Oilpulled Black



Mudslide Waist Bag

A small all-rounder in terms of function, quality and appearance: the Mudslide is a belt pouch that exceeds all expectations upon closer inspection. The Mudslide is made of embossed cowhide leather, treated with natural waxes and oils. This belt bag, with enormous vintage character, has three main compartments, all of which are protected by zips. There is a small front compartment at the front and 2 large main compartments at the top of the bag. The belly strap of the Mudslide can be easily adjusted to any size and is made of a material mix consisting of cowhide and washed canvas in a used look to further emphasise the vintage character of the bag. The leather of this rocking rough belt bag softens through personal handling, darkens over time and develops an incomparable very individual look. This little wonder is an incredibly functional and visually perfect companion for events, trips or motorbike tours to protect and transport the most important and personal things of the day. Complete your outfit now with this Jack's Inn 54 accessory of the extra class.

- Fanny pack Mudslide
- Sturdy, high-quality roughened cowhide leather
- Treated with natural waxes and oils
- Bad Ass motif illustration fully embossed on the front
- Small front compartment with nylon zipper and leather zipper puller
- Roomy front compartment with nylon zipper and leather puller
- Large compartment on the back
- Sturdy resilient lining
- Jack's Inn 54 logo embossing on the backside
- Waist strap made of leather and „washed canvas“ in vintage look adjustable up to max. 90 cm
- Carabiner closure
- Dimensions: 29 x 14 x 7 cm
- Note: Leather is tanned animal skin - a natural product. Irregular grain and possible abrasion of the color are not defects of the product, but a guarantee for the authenticity of the finely polished leather and the vegetable tanning. Traces of use, such as scratches, are also part of the intended look of brand-new bags and do not constitute a defect. It is typical for this leather to show signs of wear after a short time. It is recommended that you do not use any care products at the beginning, as this is a desired effect. Sufficient protection is provided as the leather is oiled and/or waxed.

PART#	COLOR
929777	Black
929778	Brown
929779	Oilpulled Black

[check our dealer store | www.custom-chrome-europe.com](http://www.custom-chrome-europe.com)



Custom Chrome Europe GmbH | Carl-von-Ossietzky-Straße 8 | 55459 Grolsheim/Germany
 Phone: +49 (0) 6721 - 4 007 - 0 | e-mail: info@customchrome.de | Managing Director: Thomas Noetzel
 Mainz Local Court | Commercial Registry No. 45562 | VAT No. DE811309246



World's Finest Products For Harley-Davidsons



Front Fender for Indian Sport Chief

- Short round steel fender made from 2.5 mm thick base material
- Fits the original front wheel/tire
- Handmade product
- Made in Germany
- For OEM tire 130/60B19

Part#: 930028 , Fitment: 23-24 Sport Chief , Fitment Note: Only for OEM 130/90B16 tire , Color: Raw , Material: Steel, Unit: Each , Qty.: 1



Stilet 200 Rear Fender for Indian Scout

- For conversions with 200 tires (5.5 inch wide rim).
- Suitable for pillion riders with approval (valid for Switzerland and Germany)
- Simple mounting on the original mounting points
- Original rider seat can still be used
- Handmade product
- Made in Germany
- Note: Ideal 5.5 inch wide rim and tire diameter not larger than 645 mm, does not fit with Avon 200-55 R18

Part#: 929761 , Fitment: 15-24 Indian Scout , Fitment Note: Not for 200/55-18 tire , Color: Raw , Certification: With Approval , Material: Steel , Unit: Each , Qty.: 1



Round Bobber 200

Rear Fender for Indian Scout

- For conversions with 200 rear wheel
- Kit includes steel fender with stainless steel struts and approval
- No grinding or drilling on the swingarm necessary
- Handmade product
- Made in Germany
- Note: Ideal 5.5 inch wide rim and tire diameter not larger than 645 mm, does not fit with Avon 200-55 R18

Part#: 929760 , Fitment: 15-24 Indian Scout , Fitment Note: Not for 200/55-18 tire , Color: Raw , Certification: With Approval , Material: Steel , Unit: Each , Qty.: 1



Front Fender for Indian Scout with OE Tire

- Short round steel fender made from 2.5 mm thick base material
- Fits the original front wheel/tire
- Handmade product
- Made in Germany
- For OEM 130/90B16 tire

Part#: 929762 , Fitment: 15-24 Indian Scout, (except 22 Scout Rogue , 23-24 Scout Rogue, 23-24 Scout Rogue Sixty), Fitment Note: Only for OEM 130/90B16 tire , Color: Raw , Material: Steel , Unit: Each , Qty.: 1



check our dealer store | www.custom-chrome-europe.com



Custom Chrome Europe GmbH | Carl-von-Ossietzky-Straße 8 | 55459 Grolsheim/Germany
 Phone: +49 (0) 6721 - 4 007 - 0 | e-mail: info@customchrome.de | Managing Director: Thomas Noetzel
 Mainz Local Court | Commercial Registry No. 45562 | VAT No. DE811309246